



## **Guarnizioni di tenuta per movimenti alternativi**

Listino prezzi 2011 - I

EURO

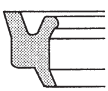
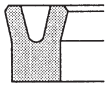
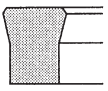

## Indice

Profilo	Riferimento	Materiale	Applicazione	Pagina
	EP	Poliuretano + cariche lubrificanti	Tenuta su pistone	1
	ASR-BA	Poliuretano + cariche lubrificanti	Tenuta su stelo + raschiatore	3
	MAD-UMAD-M	Poliuretano	Tenuta su pistone e stelo	5
	CSC	Poliuretano	Tenuta su stelo	27

## Guarnizioni di tenuta in poliuretano per movimenti alternativi serie "EP"

La serie EP è costituita da guarnizioni a labbro impiegate per la tenuta su pistone di cilindri pneumatici. Sono prodotte in poliuretano 93 Shore A addizionato con particolari cariche che ne migliorano la scorrevolezza.

Queste guarnizioni propongono diversi vantaggi, sia per il montaggio in cave poco ingombranti, che per l'efficacia e durata della tenuta.

Il profilo del labbro di tenuta arrotondato è sottile e flessibile per rispondere meglio alla pressione. Il materiale ha un basso coefficiente di attrito ed un elevato carico di rottura.

Possono essere utilizzate con aria secca previa lubrificazione al momento del montaggio.

### Condizioni di esercizio

Pressione 16 bar  
 Velocità 2 m/s  
 Temperatura (B3) -30°C +80°C

### Compounds

PUR 93 Shore A + cariche lubrif. (B3)

### Tolleranze

La figura sotto riportata indica le rugosità in  $\mu\text{mRa}$  e le tolleranze dimensionali della sede per guarnizioni di tenuta su pistone.

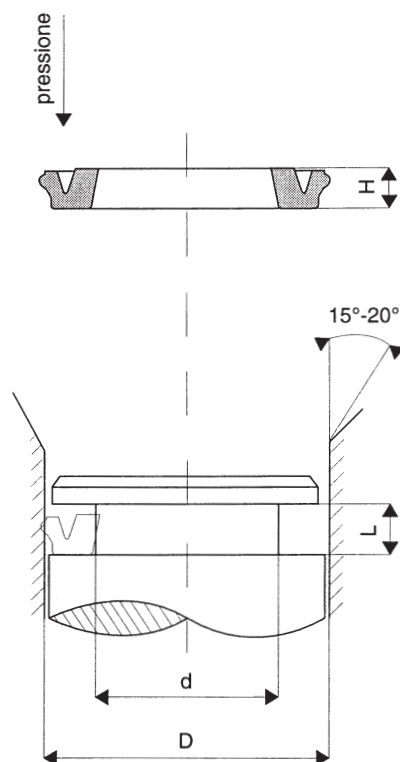
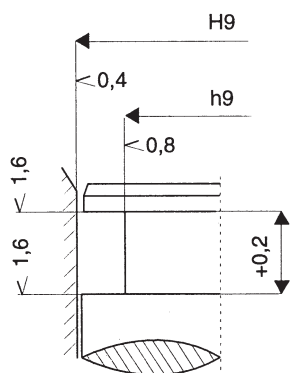



Codice	Descrizione	Dimensioni				Quantità min.	Prezzo (€ cad.)
		D (mm)	d (mm)	H (mm)	L (mm)		
25M030B3	EP 12	12	7	2,5	3,0	50	0,8042
25M040B3	EP 16	16	10	2,5	3,0	50	0,8381
25M050B3	EP 20	20	14	2,5	3,0	50	0,9051
25M060B3	EP 25	25	19	3,2	3,5	50	0,9383
25M070B3	EP 32	32	24	3,2	3,5	30	1,0391
25M080B3	EP 40	40	32	3,2	3,5	30	1,1732
25M090B3	EP 50	50	42	3,2	3,5	30	1,3071
25M100B3	EP 63	63	53	4,2	4,5	20	1,4073
25M110B3	EP 80	80	70	4,2	4,5	20	1,7763
25M120B3	EP 100	100	90	4,2	4,5	20	2,1445
25M130B3	EP 125	125	105	8,2	8,5	10	3,3509

## Guarnizioni di tenuta più raschiatore in poliuretano per movimenti alternativi serie "ASR-BA"

La serie ASR-BA è costituita da guarnizioni a labbro impiegate per la tenuta su steli di cilindri pneumatici. Sono prodotte in poliuretano 93 Shore A addizionato con particolari cariche che ne migliorano la scorrevolezza.

Oltre alla tenuta dinamica mediante il labbro "a" esercitano una tenuta raschiante con il labbro "b" (vedi figura).

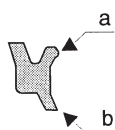

Queste guarnizioni propongono diversi vantaggi, sia per il montaggio in cave poco ingombranti, che per l'efficacia e durata della tenuta.

Il profilo del labbro di tenuta arrotondato è sottile e flessibile per rispondere meglio alla pressione. Il materiale ha un basso coefficiente d'attrito e un elevato carico di rottura.

Possono essere utilizzate con aria secca previa lubrificazione al momento del montaggio.

### Condizioni di esercizio

Pressione 16 bar  
 Velocità 2 m/s  
 Temperatura (B3) -30°C +80°C

### Compounds

PUR 93 Shore A + cariche lubrif. (B3)

### Tolleranze

La figura sotto riportata indica le rugosità in  $\mu\text{mRa}$  e le tolleranze dimensionali della sede per guarnizioni di tenuta su stelo.

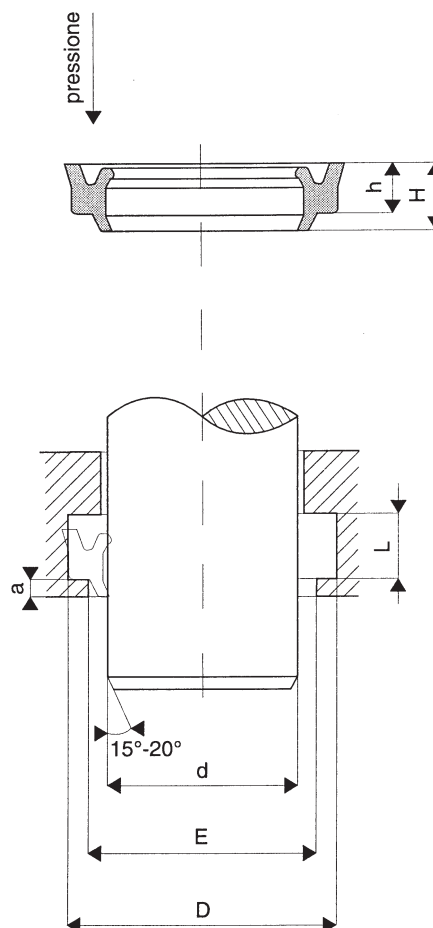
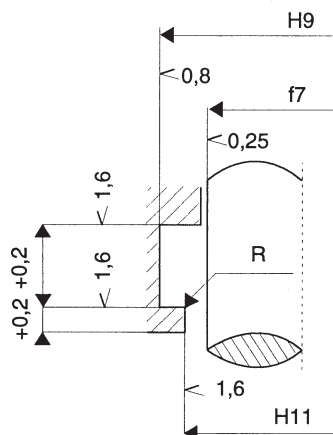

H (mm)	R (mm)	a (mm)
5,5	1,0	1,5
6,0	1,0	1,5
6,5	1,0	1,5
7,5	1,0	1,5

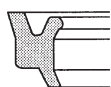

## ASR-BA

Codice	Descrizione	Dimensioni						Quantità min.	Prezzo (€ cad.)
		d (mm)	D (mm)	E (mm)	L (mm)	h (mm)	H (mm)		
25E300B3	ASR-BA 6	6	10,8	8	4,5	4	5,5	50	0,7711
25E310B3	ASR-BA 8	8	14	11	4,5	4	5,5	50	0,8042
25E320B3	ASR-BA 10	10	16,8	13	4,5	4	5,5	50	0,8381
25E325B3	ASR-BA 10/1	10	18	14	5	4,5	6	50	0,8381
25E330B3	ASR-BA 12/1	12	20	16	5	4,5	6	50	0,9051
25E340B3	ASR-BA 16	16	26	20	5,5	5	6,5	50	0,9383
25E345B3	ASR-BA 16/1	16	24	20	5	4,5	6	50	0,9383
25E350B3	ASR-BA 18/1	18	26	22	5	4,5	6	30	0,9383
25E355B3	ASR-BA 18	18	28	22	5,5	5	6,5	30	1,0052
25E360B3	ASR-BA 20	20	30	24	7	6	7,5	30	1,0391
25E370B3	ASR-BA 22	22	32	26	7	6	7,5	30	1,0391
25E380B3	ASR-BA 25	25	35	29	7	6	7,5	30	1,1062
25E390B3	ASR-BA 30	30	40	34	7	6	7,5	30	1,1732
25E400B3	ASR-BA 40	40	50	44	7	6	7,5	30	1,3071

## Guarnizioni di tenuta in poliuretano per movimenti alternativi serie "MAD-UMAD-M"

Le guarnizioni in poliuretano della serie MAD-UMAD-M sono realizzate in poliuretano 95 Shore A e vengono utilizzate per la tenuta dinamica su stelo e pistone di cilindri oleodinamici. Grazie alle caratteristiche del materiale e all'elevata durezza, queste guarnizioni garantiscono una notevole resistenza all'abrasione e all'estrusione. La sagoma e l'elasticità dei labbri, combinati a un buon compression set del materiale, permettono alle guarnizioni prestazioni elevate e una lunga durata.

Il montaggio viene eseguito in cava con spallamento riportato quando il rapporto tra il diametro della sede e la corona "s" è maggiore di 10 su pistone e 12 in cava interna.

### Condizioni di esercizio

Pressione 400 bar  
 Velocità 0,5 m/s  
 Temperatura (P5) -40°C +100°C

### Compounds

Poliuretano 95 Shore A (P5)

### Tolleranze

Le figure sotto riportate indicano rispettivamente le rugosità in  $\mu\text{mRa}$  e le tolleranze dimensionali delle sedi per guarnizioni di tenuta su stelo e pistone.

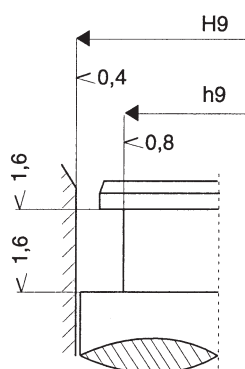
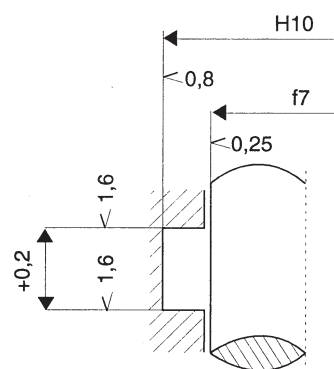
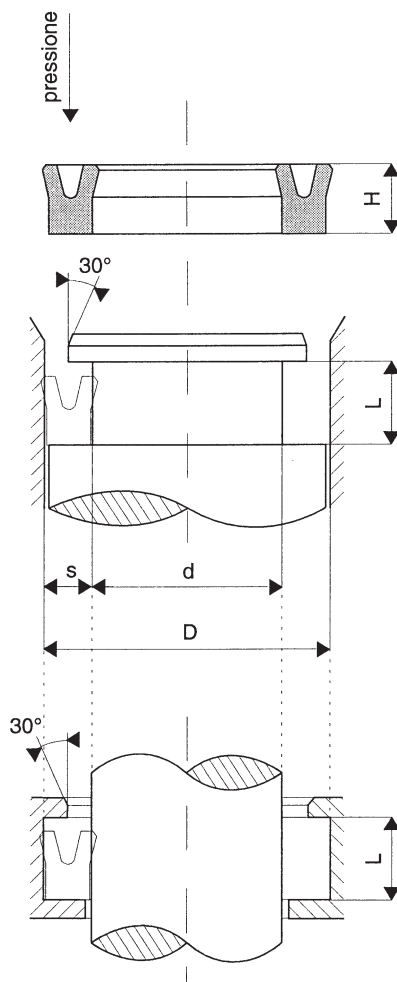

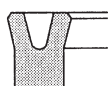

## MAD - UMAD - M

Codice	Descrizione	Dimensioni				Quantità min.	Prezzo (€ cad.)
		D (mm)	d (mm)	L (mm)	H (mm)		
25A001P5	MAD 94/1	9	4	4,5	4	30	1,0391
25A002P5	MAD 104/1	10	4	4,5	4	30	1,0391
25A003P5	MAD 104/2	10	4	5	4,5	30	1,0391
25A004P5	M4 124	12	4	4,5	4	30	1,0391
25A005P5	MAD 125/1	12	5	5,5	5	30	1,0391
25A006P5	MAD 125/2	12	5	6,5	6	30	1,0391
25A007P5	MAD 126/4	12	6	4,5	4	30	1,0391
25A008P5	MAD 126/5	12	6	6	5	30	1,0391
25A009P5	MAD 126/6	12	6	6,5	6	30	1,0391
25A010P5	MAD 126/2	12	6	9	8	30	1,0391
25A011P5	MAD 125/3	12,5	4,5	5	4,5	30	1,0391
25A012P5	MAD 126/3	12,7	6,3	4,5	4	30	1,0391
25A013P5	M4 135	13	5	4,5	4	30	1,0391
25A014P5	M4 146	14	6	4,5	4	30	1,0391
25A015P5	MAD 147/2	14	7	4,2	3,7	30	1,0391
25A016P5	MAD 147/1	14	7,7	5,5	5	30	1,0391
25A017P5	MAD 148/1	14	8	7	6	30	1,0391
25A018P5	M5 155	15	5	5,5	5	30	1,1393
25A019P5	MAD 156/1	15	6	9	8	30	1,1393
25A020P5	M4 157	15	7	4,5	4	30	1,1393
25A021P5	MAD 157/1	15	7	8	7	30	1,1393
25A022P5	MAD 158/1	15	8	6,3	5,7	30	1,1393
25A023P5	MAD 158/2	15	8	9	8	30	1,1393
25A024P5	M5 166	16	6	5,5	5	30	1,1393
25A025P5	M4 168	16	8	4,5	4	30	1,1393
25A026P5	MAD 168/1	16	8	6	5,5	30	1,1393
25A027P5	MAD 168/2	16	8	6,3	5,7	30	1,1393
25A028P5	MAD 168	16	8	6,5	6	30	1,1393
25A029P5	MAD 1610/1	16	10	6,5	6	30	1,1393
25A030P5	M4 179	17	9	4,5	4	30	1,1393
25A031P5	MAD 1711/1	17,5	11,1	5,5	5	30	1,1393
25A032P5	M5 188	18	8	5,5	5	30	1,1393
25A033P5	MAD 188	18	8	8	7,5	30	1,1393
25A034P5	MAD 188/2	18	8	10	9	30	1,1393
25A035P5	M4 1810	18	10	4,5	4	30	1,1393
25A036P5	MAD 1810/1	18	10	6	5,5	30	1,1393
25A037P5	MAD 1810	18	10	7	6	30	1,1393
25A038P5	MAD 1810/2	18	10	9	8	30	1,1393
25A039P5	MAD 1812/1	18	12	7	6	30	1,1393
25A040P5	MAD 199/2	19	9	7	6,5	30	1,1393
25A041P5	MAD 199/1	19	9	7,5	6,5	30	1,1393
25A042P5	M6 208	20	8	7	6	30	1,2734
25A043P5	MAD 208/1	20	8	9	8	30	1,2734
25A044P5	M5 2010	20	10	5,5	5	30	1,2734
25A045P5	MAD 2010	20	10	8	7,5	30	1,2734
25A046P5	MAD 2010/1	20	10	9	8	30	1,2734
25A047P5	M4 2012	20	12	4,5	4	30	1,2734
25A048P5	MAD 2012	20	12	6,5	6	30	1,2734
25A049P5	MAD 2012/1	20	12	9	8	30	1,2734
25A050P5	MAD 2013/1	20	13	7	6,3	30	1,2734



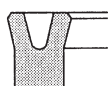

**MAD - UMAD - M**

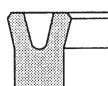
Codice	Descrizione	Dimensioni				Quantità min.	Prezzo (€ cad.)
		D (mm)	d (mm)	L (mm)	H (mm)		
25A051P5	MAD 2014/1	20	14	5,3	4,7	30	1,2734
25A052P5	MAD 2050/1	20,5	11	7	6	30	1,2734
25A053P5	MAD 2060/1	20,6	14,3	5,5	5	30	1,2734
25A054P5	MAD 2060/2	20,6	15	5,3	4,7	30	1,2734
25A055P5	MAD 2113/1	21	13	6,5	6	30	1,2734
25A056P5	MAD 2114/1	21	14,7	7	6	30	1,2734
25A057P5	MAD 228/1	22	8	9	8	30	1,3404
25A058P5	MAD 229/1	22	9	9,5	8,5	30	1,3404
25A059P5	M6 2210	22	10	7	6	30	1,3404
25A060P5	MAD 2210/1	22	10	9	8	30	1,3404
25A061P5	MAD2210	22	10	10	9	30	1,3404
25A062P5	M5 2212	22	12	5,5	5	30	1,2734
25A063P5	MAD 2212	22	12	8	7,5	30	1,2734
25A064P5	MAD 2212/3	22	12	9	8	30	1,2734
25A065P5	MAD 2212/1	22	12,5	8	7	30	1,2734
25A066P5	M4 2214	22	14	4,5	4	30	1,2734
25A067P5	MAD 2214	22	14	7	6	30	1,2734
25A068P5	MAD 2214/1	22	14	9	8	30	1,2734
25A069P5	MAD 2214/2	22	14	12	11	30	1,2734
25AB14P5	MAD 2216/1	22	16	5	4,5	30	1,4073
25A072P5	MAD 2315	23	15	6,5	6	30	1,4073
25A073P5	M6 2412	24	12	6,5	6	30	1,4073
25A074P5	MAD 2412/1	24	12	9	8	30	1,4073
25A075P5	MAD 2412	24	12	10	9	30	1,4073
25A076P5	M5 2414	24	14	5,5	5	30	1,4073
25A077P5	MAD 2414	24	14	8	7,5	30	1,4073
25A078P5	MAD 2414/1	24	14	9	8	30	1,4073
25A079P5	M4 2416	24	16	4,5	4	30	1,4073
25A080P5	MAD 2416	24	16	6,5	6	30	1,4073
25A081P5	MAD 2416/1	24	16	10	9	30	1,4073
25A082P5	M75 2510	25	10	8	7,5	30	1,5082
25A083P5	MAD 2512/1	25	12	9	8	30	1,4073
25A084P5	MAD 2512/2	25	12	11	10	30	1,4073
25A085P5	M6 2513	25	13	6,5	6	30	1,4073
25A086P5	MAD 2513	25	13	10	9	30	1,4073
25A087P5	M5 2515	25	15	5,5	5	30	1,4073
25A088P5	MAD 2515	25	15	8	7,5	30	1,4073
25A089P5	MAD 2515/1	25	15	9	8	30	1,4073
25A090P5	M4 2517	25	17	4,5	4	30	1,4073
25A091P5	MAD 2517	25	17	6,5	6	30	1,4073
25A092P5	MAD 2517/1	25	17	11	10	30	1,4073
25A093P5	MAD 2518/1	25	18	5,5	5	30	1,4073
25A094P5	MAD 2519/1	25	19	7	6	30	1,4073
25A095P5	MAD 2540/1	25,4	15,9	7	6,3	30	1,4073
25A096P5	M6 2614	26	14	6,5	6	30	1,4743
25A097P5	MAD 2614	26	14	10	9	30	1,4743
25A098P5	M5 2616	26	16	5,5	5	30	1,4073
25A099P5	MAD 2616	26	16	8	7,5	30	1,4073
25A100P5	MAD 2616/2	26	16	9	8	30	1,4073
25A101P5	MAD 2616/1	26	16,5	7	6,3	30	1,4073

**MAD - UMAD - M**

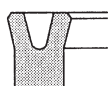
Codice	Descrizione	Dimensioni				Quantità min.	Prezzo (€ cad.)
		D (mm)	d (mm)	L (mm)	H (mm)		
25A102P5	M4 2618	26	18	4,5	4	30	1,4073
25A103P5	MAD 2618	26	18	6,5	6	30	1,4073
25A104P5	MAD 2618/1	26	18	7,5	7	30	1,4073
25A105P5	MAD 2618/2	26	18	9,5	8,5	30	1,4073
25A106P5	M6 2715	27	15	7	6	30	1,4743
25A107P5	MAD 2715	27	15	10	9	30	1,4743
25A108P5	MAD 2717	27	17	8	7,5	30	1,4073
25A109P5	MAD 2815/1	28	15	11	10	30	1,4073
25A110P5	M6 2816	28	16	7	6	30	1,4743
25A111P5	MAD 2816	28	16	10	9	30	1,4743
25A112P5	M5 2818	28	18	5,5	5	30	1,4073
25A113P5	MAD 2818	28	18	8	7,5	30	1,4073
25A114P5	MAD 2818/1	28	18	9	8	30	1,4073
25A115P5	M4 2820	28	20	4,5	4	30	1,4073
25A116P5	MAD 2820/2	28	20	5	4,5	30	1,4073
25A117P5	MAD 2820	28	20	6,5	6	30	1,4073
25A118P5	MAD 2820/1	28	20	9	8	30	1,4073
25A119P5	MAD 2822/1	28	22	9	8	30	1,4073
25A121P5	M75 3015	30	15	8	7,5	20	1,6754
25A122P5	MAD 3015/1	30	15	10	9	20	1,6754
25A123P5	M6 3018	30	18	6,5	6	20	1,6084
25A124P5	MAD 3018/1	30	18	9	8	20	1,6084
25A125P5	MAD 3018	30	18	10	9	20	1,6084
25A126P5	MAD 3019/2	30	19,5	7,5	7	20	1,6084
25A127P5	M5 3020	30	20	5,5	5	20	1,5414
25A128P5	MAD 3020	30	20	8	7,5	20	1,5414
25A129P5	MAD 3020/3	30	20	9	8	20	1,5414
25A130P5	MAD 3020/2	30	20	11	10	20	1,5414
25A131P5	MAD 3020/1	30	20,5	7	6,3	20	1,5414
25A132P5	M4 3022	30	22	4,5	4	20	1,5414
25A133P5	MAD 3022	30	22	7	6,5	20	1,5414
25A134P5	MAD 3022/2	30	22	7,5	7	20	1,5414
25A135P5	MAD 3022/3	30	22	11	10	20	1,5414
25A136P5	MAD 3022/1	30	22,5	5,5	5	20	1,5414
25A137P5	MAD 3050/1	30,5	20,3	7	6,3	20	1,5414
25A138P5	MAD 3216/1	32	16	9	8	20	1,6754
25A139P5	M6 3220	32	20	6,5	6	20	1,6084
25A140P5	MAD 3220/1	32	20	8,5	7,5	20	1,6084
25A141P5	MAD 3220	32	20	10	9	20	1,6084
25A142P5	M5 3222	32	22	5,5	5	20	1,5414
25A143P5	MAD 3222	32	22	8	7,5	20	1,5414
25A144P5	MAD 3222/1	32	22	9	8	20	1,5414
25A145P5	M4 3224	32	24	4,5	4	20	1,5414
25A146P5	MAD 3224	32	24	6,5	6	20	1,5414
25A147P5	MAD 3224/1	32	24	7,5	7	20	1,5414
25A148P5	MAD 3224/2	32	24	8	7,5	20	1,5414
25A151P5	MAD 3323	33	23	8	7,5	20	1,5414
25A152P5	M4 3325	33	25	4,5	4	20	1,5414
25A153P5	MAD 3325	33	25	6,5	6	20	1,5414
25A154P5	MAD 3325/1	33	25	11	10	20	1,5414

**MAD - UMAD - M**

Codice	Descrizione	Dimensioni				Quantità min.	Prezzo (€ cad.)
		D (mm)	d (mm)	L (mm)	H (mm)		
25A155P5	M6 3422	34	22	6,5	6	20	1,8094
25A156P5	M5 3424	34	24	5,5	5	20	1,8094
25A157P5	MAD 3424	34	24	8	7,5	20	1,8094
25A158P5	M4 3426	34	26	4,5	4	20	1,8094
25A159P5	MAD 3426	34	26	6,5	6	20	1,8094
25A160P5	UMAD3515	35	15	11	10	20	2,0105
25A161P5	M75 3520	35	20	8	7,5	20	1,8765
25A162P5	MAD 3520/1	35	20	10	9	20	1,8765
25A163P5	MAD 3520/2	35	20	13	12	20	1,8765
25A164P5	MAD 3522/2	35	22	11	10	20	1,8094
25A165P5	MAD 3522/1	35	22,3	7	6,3	20	1,8094
25A166P5	M6 3523	35	23	6,5	6	20	1,8094
25A167P5	MAD 3523/1	35	23	7,5	7	20	1,8094
25A168P5	MAD 3523	35	23	10	9	20	1,8094
25A169P5	M5 3525	35	25	5,5	5	20	1,8094
25A170P5	MAD 3525	35	25	8	7,5	20	1,8094
25A171P5	MAD 3525/1	35	25	9	8	20	1,8094
25A172P5	MAD 3525/2	35	25	11	10	20	1,8094
25A173P5	M4 3527	35	27	4,5	4	20	1,8094
25A174P5	MAD 3527	35	27	6,5	6	20	1,8094
25A175P5	MAD 3528/1	35	28	5,5	5	20	1,8094
25A176P5	MAD 3622/1	36	22	11	10	20	1,8094
25A177P5	M6 3624	36	24	6,5	6	20	1,8094
25A178P5	MAD 3624	36	24	10	9	20	1,8094
25A180P5	MAD 3626	36	26	8	7,5	20	1,8094
25A182P5	MAD 3628	36	28	6,5	6	20	1,8094
25A183P5	MAD 3628/1	36	28	7,5	7	20	1,8094
25A184P5	MAD 3650/1	36,5	23,8	7	6,3	20	1,8094
25A185P5	M6 3725	37	25	6,5	6	20	1,8094
25A186P5	MAD 3725	37	25	10	9	20	1,8094
25A187P5	M4 3729	37	29	4,5	4	20	1,8094
25A188P5	UMAD 3818	38	18	11	10	20	2,0776
25A189P5	M6 3826	38	26	6,5	6	20	2,0105
25A190P5	M5 3828	38	28	5,5	5	20	1,8765
25A191P5	MAD 3828	38	28	8	7,5	20	1,8765
25A192P5	MAD 3828/1	38	28	9	8	20	1,8765
25A193P5	M4 3830	38	30	4,5	4	20	1,8765
25A194P5	MAD 3830	38	30	6,5	6	20	1,8765
25A195P5	MAD 3830/1	38	30	8	7,5	20	1,8765
25A196P5	MAD 3810/1	38,1	25	7	6,3	20	1,9435
25A197P5	UMAD 4020	40	20	11	10	20	2,1445
25A198P5	MAD 4020/2	40	20	12	11	20	2,1445
25A199P5	MAD 4020/1	40	20	13	12	20	2,1445
25A200P5	MAD 4024/1	40	24	9	8	20	2,0776
25A201P5	M75 4025	40	25	8	7,5	20	2,0776
25A202P5	MAD 4025/2	40	25	10	9	20	2,0776
25A203P5	MAD 4025/1	40	25	11	10	20	2,0776
25A204P5	MAD 4027/1	40	27,3	7	6,3	20	2,0105
25A205P5	M6 4028	40	28	6,5	6	20	2,0105
25A206P5	MAD 4028	40	28	10	9	20	2,0105

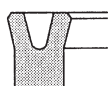
**MAD - UMAD - M**

Codice	Descrizione	Dimensioni				Quantità min.	Prezzo (€ cad.)
		D (mm)	d (mm)	L (mm)	H (mm)		
25A207P5	MAD 4028/1	40	28	11	10	20	2,0105
25A208P5	M5 4030	40	30	5,5	5	20	1,9435
25A209P5	MAD 4030	40	30	8	7,5	20	1,9435
25A210P5	MAD 4030/1	40	30	11	10	20	1,9435
25A211P5	M4 4032	40	32	4,5	4	20	1,9435
25A212P5	MAD 4032/2	40	32	6	5,5	20	1,9435
25A213P5	MAD 4032	40	32	6,5	6	20	1,9435
25A214P5	MAD 4032/1	40	32	9	8	20	1,9435
25A216P5	MAD 4130/1	41,3	28,6	9	8	20	1,9435
25A217P5	M6 4230	42	30	6,5	6	20	2,0105
25A218P5	MAD 4230	42	30	10	9	20	2,0105
25A219P5	MAD 4230/1	42	30	11	10	20	2,0776
25A220P5	M5 4232	42	32	5,5	5	20	1,9435
25A221P5	MAD 4232	42	32	8	7,5	20	1,9435
25A222P5	MAD 4232/1	42	32	11	10	20	1,9435
25A223P5	MAD 4234	42	34	6,5	6	20	1,9435
25A225P5	MAD 4330/1	43	30,3	10,5	9,5	20	2,0776
25A226P5	M5 4333	43	33	5,5	5	20	1,9435
25A228P5	MAD 4335	43	35	6,5	6	20	1,9435
25A229P5	MAD 4335/1	43	35	9	8	20	1,9435
25A230P5	M6 4432	44	32	6,5	6	20	2,0776
25A231P5	MAD 4432	44	32	10	9	20	2,0776
25A232P5	M5 4434	44	34	5,5	5	20	1,9435
25A233P5	MAD 4434	44	34	8	7,5	20	1,9435
25A234P5	MAD 4436	44	36	6,5	6	20	1,9435
25A235P5	UMAD 4525	45	25	11	10	20	2,3794
25A236P5	M75 4530	45	30	8	7,5	20	2,3124
25A237P5	MAD 4530/2	45	30	10	9	20	2,3124
25A238P5	MAD 4530/1	45	30	10,5	9,5	20	2,3124
25A239P5	MAD 4530/3	45	30	11	10	20	2,3124
25A240P5	MAD 4532/1	45	32	11	10	20	2,2116
25A241P5	M6 4533	45	33	6,5	6	20	2,2116
25A242P5	MAD 4533	45	33	10	9	20	2,2116
25A243P5	MAD 4534/1	45	34	10	9	20	2,2116
25A244P5	M5 4535	45	35	5,5	5	20	2,1115
25A245P5	MAD 4535	45	35	8	7,5	20	2,1115
25A246P5	MAD 4535/4	45	35	9	8	20	2,1115
25A247P5	MAD 4535/3	45	35	11	10	20	2,1115
25A248P5	MAD 4535/1	45	35,5	7,5	7	20	2,2116
25A249P5	MAD 4537	45	37	6,5	6	20	2,0776
25A250P5	MAD 4538/1	45	38	5,5	5	20	2,2116
25A251P5	M5 4636	46	36	5,5	5	20	2,1115
25A252P5	MAD 4636	46	36	8	7,5	20	2,1115
25A253P5	MAD 4636/1	46	36	11	10	20	2,1115
25A254P5	MAD 4638	46	38	6,5	6	20	2,0776
25A255P5	MAD 4638/1	46	38	7,5	7	20	2,0776
25A256P5	M6 4735	47	35	6,5	6	20	2,2116
25A257P5	MAD 4735	47	35	10	9	20	2,2116
25A258P5	MAD 4832/1	48	32	11	10	20	2,5466
25A259P5	MAD 4835/1	48	35	11	10	20	2,3794

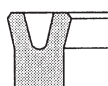
**MAD - UMAD - M**

Codice	Descrizione	Dimensioni				Quantità min.	Prezzo (€ cad.)
		D (mm)	d (mm)	L (mm)	H (mm)		
25A260P5	M6 4836	48	36	6,5	6	20	2,3794
25A261P5	MAD 4836	48	36	10	9	20	2,3794
25A262P5	M5 4838	48	38	5,5	5	20	2,2785
25A263P5	MAD 4838	48	38	8	7,5	20	2,2785
25A264P5	MAD 4840	48	40	6,5	6	20	2,1445
25A265P5	MAD 4840/1	48	40	12	11	20	2,1445
25A266P5	UMAD 5030	50	30	11	10	20	2,6138
25A267P5	MAD 5030/1	50	30	13	12	20	2,6138
25A268P5	MAD 5032/1	50	32	11	10	20	2,6138
25A270P5	MAD 5034/1	50	34	15	14	20	2,6806
25A271P5	M75 5035	50	35	8	7,5	20	2,4796
25A272P5	MAD 5035/1	50	35	10	9	20	2,5466
25A273P5	MAD 5035/2	50	35	11	10	20	2,5466
25A274P5	MAD 5035	50	35	12	11	20	2,5466
25A275P5	M6 5038	50	38	6,5	6	20	2,3794
25A276P5	MAD 5038	50	38	10	9	20	2,3794
25A277P5	MAD 5038/1	50	38	12	11	20	2,3794
25A278P5	M5 5040	50	40	5,5	5	20	2,2785
25A279P5	MAD 5040/3	50	40	7,5	7	20	2,2785
25A280P5	MAD 5040	50	40	8	7,5	20	2,2785
25A281P5	MAD 5040/4	50	40	9	8	20	2,2785
25A282P5	MAD 5040/1	50	40	11	10	20	2,2785
25A283P5	MAD 5040/2	50	40,7	7,5	7	20	2,3794
25A284P5	MAD 5042	50	42	6,5	6	20	2,1445
25A285P5	MAD 5042/1	50	42	9	8,5	20	2,1445
25A286P5	MAD 5044/1	50	44	9,5	8,5	20	2,3794
25A287P5	MAD 5041/1	50,8	41,3	6	5,5	20	2,3794
25A288P5	MAD 5135	51	35	13	12	20	2,4796
25A289P5	MAD 5141	51	41	8	7,5	20	2,1445
25A290P5	UMAD 5232	52	32	11	10	20	2,6806
25A292P5	M6 5240	52	40	6,5	6	20	2,3794
25A293P5	MAD 5240	52	40	10	9	20	2,3794
25A294P5	M5 5242	52	42	5,5	5	20	2,2785
25A295P5	MAD 5242	52	42	8	7,5	20	2,2785
25A296P5	MAD 5242/2	52	42	10	9	20	2,2785
25A298P5	MAD 5244	52	44	6,5	6	20	2,2785
25A299P5	MAD 5338/1	53	38	9	8	20	2,5466
25A300P5	MAD 5343	53	43	8	7,5	20	2,4126
25A301P5	MAD 5345	53	45	6,5	6	20	2,3124
25A302P5	MAD 5345/4	53	45	7,5	7	20	2,3124
25A303P5	MAD 5345/2	53	45	11	10	20	2,3124
25A304P5	MAD 5345/3	53	45	13	12	20	2,3124
25A305P5	M6 5442	54	42	6,5	6	20	2,6806
25A306P5	M5 5444	54	44	5,5	5	20	2,4126
25A307P5	MAD 5444	54	44	8	7,5	20	2,4126
25A308P5	MAD 5446	54	46	6,5	6	20	2,3124
25A309P5	UMAD 5535	55	35	11	10	20	2,8485
25A310P5	MAD 5535/1	55	35	13	12	20	2,8485
25A311P5	MAD 5538/1	55	38	11	10	20	2,7816
25A313P5	M75 5540	55	40	8	7,5	20	2,6806

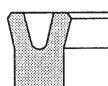

**MAD - UMAD - M**

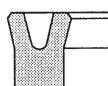
Codice	Descrizione	Dimensioni				Quantità min.	Prezzo (€ cad.)
		D (mm)	d (mm)	L (mm)	H (mm)		
25A314P5	MAD 5540/1	55	40	11	10	20	2,7816
25A315P5	MAD 5540	55	40	12	11	20	2,7816
25A316P5	M6 5543	55	43	6,5	6	20	2,6806
25A317P5	MAD 5543	55	43	10	9	20	2,6806
25A318P5	M5 5545	55	45	5,5	5	20	2,5466
25A319P5	MAD 5545/2	55	45	7,5	7	20	2,5466
25A320P5	MAD 5545	55	45	8	7,5	20	2,5466
25A321P5	MAD 5545/1	55	45	11	10	20	2,5466
25A322P5	MAD 5547	55	47	6,5	6	20	2,4126
25A323P5	MAD 5640/1	56	40	11	10	20	2,7816
25A325P5	M6 5644	56	44	6,5	6	20	2,6806
25A326P5	M5 5646	56	46	5,5	5	20	2,5466
25A327P5	MAD 5646	56	46	8	7,5	20	2,5466
25A330P5	M6 5745	57	45	6,5	6	20	2,6806
25A331P5	MAD 5745	57	45	10	9	20	2,6806
25A332P5	MAD 5638/1	56	38	11	10	20	3,0829
25A333P5	MAD 5845/1	58	45	11	10	20	2,8149
25A334P5	M6 5846	58	46	6,5	6	20	2,8149
25A335P5	MAD 5848/1	58	48	11	10	20	2,7478
25A336P5	MAD 5850/1	58	50	5,5	5	20	2,5466
25A337P5	MAD 5850	58	50	6,5	6	20	2,5466
25A338P5	UMAD 6040	60	40	11	10	20	3,0829
25AA41P5	MAD 6040/1	60	40	13	12	20	3,0829
25A339P5	MAD 6040/3	60	40	14	13	20	3,0829
25A340P5	MAD 6040/2	60	40	19	18	20	3,3846
25A342P5	M75 6045	60	45	8	7,5	20	3,0158
25A343P5	MAD 6045/1	60	45	11	10	20	3,0158
25A344P5	MAD 6045	60	45	12	11	20	3,0158
25A345P5	M6 6048	60	48	6,5	6	20	2,8149
25A346P5	MAD 6048	60	48	10	9	20	2,8149
25A347P5	M5 6050	60	50	5,5	5	20	2,7478
25A348P5	MAD 6050	60	50	8	7,5	20	2,7478
25A349P5	MAD 6050/1	60	50	11	10	20	2,7478
25A350P5	MAD 6050/2	60	50	12	11	20	2,7478
25A351P5	MAD 6052	60	52	6,5	6	20	2,5466
25A352P5	MAD 6145	61	45	13	12	20	3,0158
25A353P5	MAD 6148/1	61	48,3	7	6,3	20	2,8149
25A354P5	MAD 6246	62	46	13	12	20	3,2168
25A355P5	M6 6250	62	50	6,5	6	20	2,8149
25A356P5	MAD 6250	62	50	10	9	20	2,8149
25A357P5	MAD 6252/1	62	52	13	12	20	2,7478
25A358P5	UMAD 6343	63	43	11	10	20	3,0829
25A359P5	MAD 6345/1	63	45	11	10	20	3,0829
25A360P5	MAD 6350/1	63	50	7	6,5	20	2,9489
25A361P5	M6 6351	63	51	6,5	6	20	2,8149
25A362P5	MAD 6351	63	51	10	9	20	2,8149
25A363P5	M5 6353	63	53	5,5	5	20	2,7478
25A364P5	MAD 6353/2	63	53	7,5	7	20	2,7478
25A365P5	MAD 6353	63	53	8	7,5	20	2,7478
25A366P5	MAD 6353/1	63	53	13	12	20	2,8818

**MAD - UMAD - M**

Codice	Descrizione	Dimensioni				Quantità min.	Prezzo (€ cad.)
		D (mm)	d (mm)	L (mm)	H (mm)		
25AA95P5	MAD 6440/1	64	40	11	10	20	3,0829
25A367P5	MAD 6446/1	64	46,3	9,5	8,8	20	3,0829
25A368P5	M6 6452	64	52	6,5	6	20	2,9489
25A369P5	MAD 6540/1	65	40	13	12	20	3,3846
25A370P5	UMAD 6545	65	45	11	10	20	3,2506
25A371P5	MAD 6545/1	65	45	13	12	20	3,2506
25A373P5	M75 6550	65	50	8	7,5	20	3,0829
25A374P5	MAD 6550	65	50	12	11	20	3,0829
25A375P5	M6 6553	65	53	6,5	6	20	2,9489
25A376P5	MAD 6553	65	53	10	9	20	2,9489
25A377P5	M5 6555	65	55	5,5	5	20	2,8818
25A378P5	MAD 6555	65	55	8	7,5	20	2,8818
25A379P5	MAD 6555/1	65	55	11	10	20	2,8818
25A380P5	MAD 6555/2	65	55	13	12	20	2,8818
25A381P5	MAD 6650	66	50	13	12	20	3,2506
25A382P5	M6 6654	66	54	6,5	6	20	3,1500
25A384P5	MAD 6656	66	56	8	7,5	20	2,8818
25A385P5	MAD 6656/1	66	56	12	11	20	3,0158
25A387P5	M6 6755	67	55	6,5	6	20	3,1500
25A388P5	MAD 6755	67	55	10	9	20	3,1500
25A389P5	MAD 6850/1	68	50	11	10	20	3,5519
25A390P5	MAD 7040/1	70	40	16	15	20	4,1551
25A391P5	UMAD 7045	70	45	13	12	20	3,6860
25A393P5	UMAD 7050	70	50	11	10	20	3,3846
25A394P5	MAD 7050/1	70	50	13	12	20	3,3846
25A395P5	MAD 7050	70	50	16	15	20	3,3846
25A396P5	MAD 7050/2	70	50	19	18	20	3,6860
25A397P5	MAD 7054	70	54	13	12	20	3,2839
25A398P5	M75 7055	70	55	8	7,5	20	3,2839
25A399P5	MAD 7055	70	55	12	11	20	3,2839
25A400P5	MAD 7055/1	70	55	13	12	20	3,2839
25A402P5	MAD 7058	70	58	10	9	20	3,1500
25A403P5	M5 7060	70	60	5,5	5	20	3,0158
25A404P5	MAD 7060	70	60	8	7,5	20	3,0158
25A405P5	MAD 7060/4	70	60	9	8	20	3,0158
25A406P5	MAD 7060/1	70	60	11	10	20	3,0158
25A407P5	MAD 7060/3	70	60	12	11	20	3,0158
25A408P5	MAD 7060/2	70	60	13	12	20	3,0158
25A410P5	MAD 7252/1	72	52	13	12	20	3,3846
25A411P5	MAD 7256	72	56	13	12	20	3,2168
25A412P5	MAD 7260	72	60	10	9	20	3,1500
25A414P5	MAD 7262/1	72	62	12	11	20	3,0829
25A415P5	MAD 7357/1	73	57,1	12	11	20	3,4517
25A416P5	M5 7363	73	63	5,5	5	20	3,2168
25A417P5	MAD 7363	73	63	8	7,5	20	3,2168
25A418P5	MAD 7540/1	75	40	11	10	20	4,4570
25A419P5	UMAD 7550	75	50	13	12	20	4,0212
25A420P5	MAD 7550	75	50	20	18,5	20	4,2221
25A421P5	UMAD 7555	75	55	11	10	20	3,5519
25A422P5	MAD 7555/1	75	55	13	12	20	3,5519

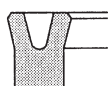



**MAD - UMAD - M**

Codice	Descrizione	Dimensioni				Quantità min.	Prezzo (€ cad.)
		D (mm)	d (mm)	L (mm)	H (mm)		
25A423P5	MAD 7555	75	55	16	15	20	3,5519
25A424P5	MAD 7555/2	75	55	19	18	20	3,8539
25A426P5	M75 7560	75	60	8	7,5	20	3,4517
25A427P5	MAD 7560/1	75	60	11	10	20	3,4517
25A428P5	MAD 7560	75	60	12	11	20	3,4517
25A429P5	MAD 7560/2	75	60	13	12	20	3,4517
25A430P5	MAD 7563	75	63	10	9	20	3,2839
25A431P5	MAD 7563/1	75	63	11	10	20	3,2839
25A432P5	M5 7565	75	65	5,5	5	20	3,2168
25A433P5	MAD 7565	75	65	8	7,5	20	3,2168
25A434P5	MAD 7565/1	75	65	11	10	20	3,2168
25A435P5	MAD 7565/2	75	65	13	12	20	3,2168
25A436P5	MAD 7660	76	60	13	12	20	3,6190
25A437P5	MAD 7666/1	76	66	9	8	20	3,2839
25A439P5	MAD 7765	77	65	10	9	20	3,4517
25A440P5	MAD 7767/1	77	67	13	12	20	3,3509
25A441P5	MAD 7862/1	78	62	13	12	20	3,6190
25A442P5	UMAD 8055	80	55	13	12	10	4,3229
25A443P5	MAD 8055	80	55	20	18,5	10	4,9932
25A444P5	UMAD 8060	80	60	11	10	10	3,6860
25A445P5	MAD 8060/1	80	60	13	12	10	3,6860
25A446P5	MAD 8060	80	60	16	15	10	3,6860
25A447P5	MAD 8060/2	80	60	19	18	10	4,0212
25A448P5	MAD 8064	80	64	13	12	10	3,7530
25A449P5	M75 8065	80	65	8	7,5	10	3,6190
25A450P5	MAD 8065	80	65	12	11	10	3,6190
25A451P5	MAD 8065/1	80	65	13	12	10	3,6190
25A452P5	MAD 8066/1	80	66	11	10	10	3,6190
25A453P5	MAD 8066/2	80	66	14	13	10	3,6190
25A454P5	MAD 8068	80	68	10	9	10	3,4517
25A455P5	M5 8070	80	70	5,5	5	10	3,3509
25A456P5	MAD 8070	80	70	8	7,5	10	3,3509
25A457P5	MAD 8070/3	80	70	9	8	10	3,3509
25A458P5	MAD 8070/2	80	70	11	10	10	3,3509
25A459P5	MAD 8070/1	80	70	13	12	10	3,3509
25A461P5	MAD 8266	82	66	13	12	10	4,0212
25A462P5	MAD 8270	82	70	10	9	10	3,6528
25A464P5	UMAD 8560	85	60	13	12	10	4,4570
25A465P5	MAD 8560	85	60	13,5	12,5	10	4,6913
25A466P5	MAD 8560/1	85	60	20	18,5	10	5,0263
25A467P5	UMAD 8565	85	65	11	10	10	3,8539
25A468P5	MAD 8565/1	85	65	13	12	10	3,8539
25A469P5	MAD 8565	85	65	16	15	10	3,8539
25A470P5	MAD 8569	85	69	13	12	10	5,0263
25A471P5	M75 8570	85	70	8	7,5	10	3,7868
25A472P5	MAD 8570	85	70	12	11	10	3,7868
25A473P5	MAD 8570/2	85	70	13	12	10	3,7868
25A475P5	MAD 8573	85	73	10	9	10	3,6528
25A476P5	M5 8575	85	75	5,5	5	10	3,5519
25A478P5	MAD 8575	85	75	8	7,5	10	3,5519

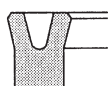

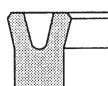

**MAD - UMAD - M**

Codice	Descrizione	Dimensioni				Quantità min.	Prezzo (€ cad.)
		D (mm)	d (mm)	L (mm)	H (mm)		
25A479P5	MAD 8575/2	85	75	13	12	10	3,5519
25A481P5	MAD 8775	87	75	10	9	10	3,8539
25A482P5	MAD 9060/1	90	60	16	15	10	5,3953
25A483P5	UMAD 9065	90	65	13	12	10	4,6243
25A484P5	MAD 9065	90	65	20	18,5	10	5,3953
25A485P5	UMAD 9070	90	70	11	10	10	4,0212
25A486P5	MAD 9070/1	90	70	13	12	10	4,0212
25A487P5	MAD 9070	90	70	16	15	10	4,0212
25A488P5	MAD 9070/2	90	70	19	18	10	4,3229
25A489P5	MAD 9074	90	74	13	12	10	6,0316
25A490P5	M75 9075	90	75	8	7,5	10	3,9208
25A491P5	MAD 9075	90	75	12	11	10	3,9208
25A492P5	MAD 9075/1	90	75	13	12	10	3,9208
25A493P5	MAD 9078	90	78	10	9	10	3,8539
25A494P5	M5 9080	90	80	5,5	5	10	3,7530
25A495P5	MAD 9080	90	80	8	7,5	10	3,7530
25A496P5	MAD 9080/1	90	80	11	10	10	3,7530
25A497P5	MAD 9080/2	90	80	13	12	10	3,7530
25A499P5	MAD 9175	91	75	13	12	10	6,0316
25A500P5	MAD 9276	92	76	13	12	10	4,1551
25A501P5	MAD 9280	92	80	10	9	10	4,0212
25A502P5	MAD 9282/1	92	82	6,5	6	10	3,8871
25A503P5	MAD 9282/2	92	82	11	10	10	3,8871
25A504P5	MAD 9378/1	93	78	11,5	10,5	10	4,1551
25A505P5	UMAD 9570	95	70	13	12	10	4,9261
25A506P5	MAD 9570	95	70	20	18,5	10	6,7018
25A507P5	MAD 9575/1	95	75	13	12	10	4,3229
25A508P5	MAD 9575	95	75	16	15	10	4,3229
25A510P5	M75 9580	95	80	8	7,5	10	4,1551
25A511P5	MAD 9580	95	80	12	11	10	4,1551
25A512P5	MAD 9580/1	95	80	13	12	10	4,1551
25A513P5	MAD 9583	95	83	10	9	10	4,0212
25A514P5	M5 9585	95	85	5,5	5	10	3,8871
25A515P5	MAD 9585	95	85	8	7,5	10	3,8871
25A516P5	MAD 9585/2	95	85	9,5	8,5	10	3,8871
25A517P5	MAD 9585/1	95	85	12	11	10	3,8871
25A518P5	MAD 9585/3	95	85	13	12	10	3,8871
25A519P5	MAD 9680	96	80	13	12	10	5,4955
25A520P5	MAD 9684/1	96	84	11	10	10	4,2221
25A521P5	MAD 9785	97	85	10	9	10	4,2221
25A523P5	UMAD 10075	100	75	13	12	10	5,2273
25A524P5	MAD 10075	100	75	20	18,5	10	7,0368
25A525P5	UMAD 10080	100	80	11	10	10	4,8591
25A526P5	MAD 10080/2	100	80	13	12	10	4,8591
25A527P5	MAD 10080	100	80	16	15	10	4,8591
25A529P5	M75 10085	100	85	8	7,5	10	4,3899
25A530P5	MAD 10085	100	85	12	11	10	4,3899
25A531P5	MAD 10085/1	100	85	13	12	10	4,3899
25A532P5	MAD 10088	100	88	10	9	10	4,2221
25A533P5	M5 10090	100	90	5,5	5	10	4,0880

**MAD - UMAD - M**

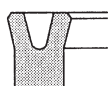
Codice	Descrizione	Dimensioni				Quantità min.	Prezzo (€ cad.)
		D (mm)	d (mm)	L (mm)	H (mm)		
25A534P5	MAD 10090	100	90	8	7,5	10	4,0880
25A535P5	MAD 10090/3	100	90	9	8	10	4,0880
25A536P5	MAD 10090/1	100	90	11	10	10	4,0880
25A537P5	MAD 10090/2	100	90	13	12	10	4,0880
25A540P5	MAD 10160/1	101,6	82,55	10,5	9,5	10	5,2273
25A541P5	MAD 10290	102	90	10	9	10	4,3899
25A542P5	MAD 10290/1	102	90	11	10	10	4,3899
25A545P5	MAD 10585/1	105	85	13	12	10	5,2273
25A546P5	MAD 10585	105	85	16	15	10	5,2273
25A547P5	MAD 10585/2	105	85	19	18	10	5,5625
25A549P5	M75 10590	105	90	8	7,5	10	4,6913
25A550P5	MAD 10590	105	90	12	11	10	4,6913
25A551P5	MAD 10590/1	105	90	13	12	10	4,6913
25A553P5	M5 10595	105	95	5,5	5	10	4,2221
25A554P5	MAD 10595	105	95	8	7,5	10	4,2221
25A555P5	MAD 10690	196	90	13	12	10	4,9932
25A556P5	MAD 10795	107	95	10	9	10	4,7583
25A558P5	UMAD 11085	110	85	13	12	10	5,5625
25A560P5	UMAD 11090	110	90	11	10	10	5,5625
25A561P5	MAD 11090/1	110	90	13	12	10	5,5625
25A562P5	MAD 11090	110	90	16	15	10	5,5625
25A563P5	MAD 11090/2	110	90	19	18	10	5,8644
25A565P5	M75 11095	110	95	8	7,5	10	4,9932
25A566P5	MAD 11095	110	95	12	11	10	4,9932
25A567P5	MAD 11095/1	110	95	16	15	10	4,9932
25A568P5	MAD 11098	110	98	10	9	10	4,7583
25A569P5	M5 110100	110	100	5,5	5	10	4,6243
25A570P5	MAD 110100	110	100	8	7,5	10	4,6243
25A572P5	MAD 11295/1	112	95	13	12	10	5,7635
25A574P5	MAD 112100	112	100	10	9	10	4,9261
25A578P5	UMAD 11590	115	90	13	12	10	5,8644
25A580P5	UMAD 11595	115	95	11	10	10	5,8644
25A581P5	MAD 11595/2	115	95	13	12	10	5,8644
25A583P5	MAD 11595/1	115	95	19	18	10	6,1656
25A585P5	M75 115100	115	100	8	7,5	10	5,3953
25A586P5	MAD 115100	115	100	12	11	10	5,3953
25A587P5	MAD 115100/1	115	100	13	12	10	5,3953
25A592P5	MAD 12090	120	90	19	18	5	7,7070
25A593P5	UMAD 12095	120	95	13	12	5	6,1656
25A595P5	UMAD 120100	120	100	11	10	5	6,1656
25A596P5	MAD 120100/1	120	100	13	12	5	6,1656
25A597P5	MAD 120100	120	100	16	15	5	6,1656
25A598P5	MAD 120100/2	120	100	19	18	5	6,4675
25A599P5	M75 120105	120	105	8	7,5	5	5,7635
25A600P5	MAD 120105/1	120	105	9	8	5	5,7635
25A601P5	MAD 120105	120	105	12	11	5	5,7635
25A603P5	MAD 121111/1	121	111	6,5	6	5	5,1943
25A604P5	MAD 122110	122	110	10	9	5	5,3953
25A605P5	UMAD 125100	125	100	13	12	5	6,6347
25A606P5	MAD 125100/1	125	100	16	15	5	7,3049

**MAD - UMAD - M**

Codice	Descrizione	Dimensioni				Quantità min.	Prezzo (€ cad.)
		D (mm)	d (mm)	L (mm)	H (mm)		
25A608P5	MAD 125105/1	125	105	13	12	5	6,4675
25A609P5	MAD 125105	125	105	16	15	5	6,4675
25A610P5	M75 125110	125	110	8	7,5	5	10,9909
25A611P5	MAD 125110	125	110	12	11	5	6,0985
25A612P5	MAD 125110/2	125	110	13	12	5	6,0985
25A613P5	MAD 125110/1	125	110	16	15	5	6,0985
25A614P5	MAD 125113	125	113	10	9	5	5,6966
25A616P5	MAD 126115/1	126	115	16	15	5	5,6966
25A618P5	MAD 127115	127	115	10	9	5	5,6966
25A619P5	MAD 130100/2	130	100	13	12	5	7,1039
25A621P5	UMAD 130105	130	105	13	12	5	6,9367
25A622P5	MAD 130105	130	105	20	18,5	5	8,4443
25A623P5	UMAD 130110	130	110	11	10	5	6,7687
25A624P5	MAD 130110	130	110	16	15	5	6,7687
25A625P5	MAD 130110/1	130	110	19	18	5	7,1039
25A626P5	M75 130115	130	115	8	7,5	5	6,4006
25A627P5	MAD 130115	130	115	12	11	5	6,4006
25A630P5	MAD 130120/1	130	120	15	14	5	6,7687
25A632P5	UMAD 135110	135	110	13	12	5	7,7070
25A633P5	MAD 135110	135	110	20	18,5	5	9,2485
25A634P5	MAD 135115/1	135	115	16	15	5	7,3049
25A636P5	MAD 135120	135	120	12	11	5	7,3049
25A637P5	MAD 135120/1	135	120	16	15	5	7,3049
25A639P5	MAD 137125	137	125	10	9	5	6,5346
25A640P5	UMAD 140115	140	115	13	12	5	8,0421
25A641P5	MAD 140115/1	140	115	16	15	5	8,0421
25A643P5	UMAD 140120	140	120	11	10	5	8,0421
25A644P5	MAD 140120	140	120	16	15	5	8,0421
25A647P5	MAD 140125	140	125	12	11	5	7,5398
25A653P5	MAD 145125/1	145	125	14	13	5	8,3103
25A654P5	MAD 145125	145	125	16	15	5	8,3103
25A659P5	MAD 147135	147	135	10	9	5	7,1039
25A660P5	UMAD 150125	150	125	13	12	5	8,8463
25A662P5	UMAD 150130	150	130	11	10	5	8,4443
25A663P5	MAD 150130	150	130	16	15	5	8,4443
25A665P5	MAD 150138	150	138	10	9	5	7,3049
25A666P5	MAD 151141/1	151	141	15	14	5	7,7070
25A667P5	MAD 152140	152	140	10	9	5	7,3049
25A668P5	MAD 154142/1	154	142	11	10	5	7,7070
25A669P5	MAD 155125/1	155	125	16	15	5	9,9857
25A672P5	MAD 155135/1	155	135	16	15	5	9,2485
25A673P5	MAD 155140	155	140	12	11	5	8,0421
25A674P5	MAD 155140/1	155	140	16	15	5	8,0421
25A681P5	MAD 160135/1	160	135	16	15	5	9,9857
25A683P5	UMAD 160140	160	140	11	10	5	9,9857
25A684P5	MAD 160140	160	140	16	15	5	9,9857
25A685P5	MAD 160145	160	145	12	11	5	8,4443
25A690P5	MAD 165150	165	150	12	11	5	8,4443
25A693P5	MAD 169154/1	169	154	12	11	5	8,8463
25A696P5	UMAD 170145	170	145	13	12	5	11,5270

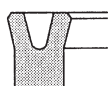

**MAD - UMAD - M**

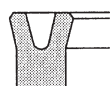
Codice	Descrizione	Dimensioni				Quantità min.	Prezzo (€ cad.)
		D (mm)	d (mm)	L (mm)	H (mm)		
25A700P5	MAD 170150	170	150	16	15	5	10,7899
25A701P5	MAD 170150/2	170	150	19	18	5	11,5270
25A702P5	MAD 170155	170	155	12	11	5	8,8463
25A705P5	MAD 172162/1	172	162	15	14	5	9,5835
25A708P5	MAD 175160	175	160	12	11	5	9,5835
25A710P5	MAD 177165	177	165	10	9	5	8,8463
25A715P5	MAD 180160	180	160	16	15	3	11,5270
25A717P5	MAD 180165	180	165	12	11	3	10,3877
25A727P5	MAD 190170	190	170	16	15	3	13,4035
25A731P5	MAD 193183/1	193	183	15	14	3	13,8728
25A734P5	MAD 195180	195	180	12	11	3	13,8728
25A736P5	MAD 197185	197	185	10	9	13	11,5270
25A739P5	MAD 200170/2	200	170	19	18	3	19,2341
25A742P5	MAD 200175/1	200	175	16	15	3	15,4141
25A744P5	MAD 200180	200	180	16	15	3	15,0119
25A746P5	MAD 200185	200	185	12	11	3	13,0684
25A747P5	MAD 200188	200	188	10	9	3	11,5270
25A751P5	MAD 205190	205	190	12	11	3	13,8728
25A752P5	MAD 205193	205	193	10	9	3	12,3312
25A758P5	MAD 210190	210	190	16	15	3	16,0842
25A768P5	MAD 217207/1	217	207	15	14	3	16,0842
25A773P5	MAD 220200	220	200	16	15	3	16,9555
25A775P5	MAD 220208	220	208	10	9	3	13,8728
25A785P5	MAD 230210	230	210	16	15	3	18,4968
25A799P5	MAD 240220	240	220	16	15	3	20,0384
25A812P5	MAD 250230	250	230	16	15	3	21,5797

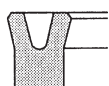

### MAD - UMAD - M (colata)

Codice	Descrizione	Dimensioni				Quantità min.	Prezzo (€ cad.)
		D (mm)	d (mm)	L (mm)	H (mm)		
25A528P5	MAD 10084	100	84	13	12		14,5334
25AB04P5	MAD 10085/2	100	85	27	25		26,2407
25A538P5	MAD 10185	101	85	13	12		14,7754
25A539P5	MAD 10286	102	86	13	12		14,8563
25A543P5	UMAD 10580	105	80	13	12		19,1354
25A544P5	MAD 10580	105	80	20	18,5		21,2346
25A548P5	MAD 10589	105	89	13	12		15,0985
25A552P5	MAD 10593	105	93	10	9		11,3845
25A557P5	MAD 11080/1	110	80	16	15		25,6757
25A559P5	MAD 11085	110	85	20	18,5		22,1228
25A564P5	MAD 11094	110	94	13	12		15,6636
25A571P5	MAD 11195	111	95	13	12		15,7444
25A573P5	MAD 11296	112	96	13	12		15,8252
25A575P5	MAD 112102	112	102	12	11		12,1110
25A576P5	MAD 11430/1	114,3	88,9	15	14		22,2844
25A577P5	MAD 11430/2	114,3	100	12	11		14,4526
25A579P5	MAD 11590	115	90	13	20		20,5888
25A583P5	MAD 11595/1	115	95	19	18		22,6879
25A582P5	MAD 11595	115	95	20	15		23,0918
25A584P5	MAD 11599	115	99	13	12		16,0673
25A588P5	MAD 115103	115	103	10	9		12,0305
25A589P5	MAD 116100	116	100	13	12		16,1481
25A590P5	MAD 117105	117	105	10	9		12,1110
25A591P5	MAD 12090/1	120	90	16	15		27,7747
25A594P5	MAD 12095	120	95	20	18,5		23,9799
25A602P5	MAD 120108	120	108	11	9		12,8378
25A607P5	MAD 125100	125	100	20	18,5		24,8681
25A615P5	MAD 125113/1	125	113	10,5	9,5		12,9184
25AB11P5	MAD 125115/1	125	115	13	12		22,2035
25A617P5	MAD 127112	127	112	12	11		15,9059
25A620P5	MAD 130100/1	130	100	16	15		29,9548
25A628P5	MAD 130118	130	118	10	9		12,9184
25A629P5	MAD 130118/1	130	118	11	10		13,4837
25A631P5	MAD 132120	132	120	10	9		12,9993
25A635P5	M75 135120	135	120	8	7,5		13,8873
25A638P5	MAD 135123	135	123	10	9		13,2414
25A642P5	MAD 140115	140	115	20	18,5		27,6132
25A645P5	MAD 140120/1	140	120	19	18		26,8058
25A646P5	M75 140125	140	125	8	7,5		14,2102
25A648P5	MAD 140128	140	128	10	9		13,4837
25A649P5	MAD 142130	142	130	10	9		13,6452
25A650P5	MAD 145115/1	145	115	13	12		28,4206
25A651P5	UMAD 145120	145	120	13	12		25,0295
25A652P5	MAD 145120	145	120	20	18,5		28,5014
25A655P5	MAD 145125/2	145	125	19	18		27,6132
25A656P5	MAD 145130	145	130	12	11		17,5206
25A657P5	MAD 145133	145	133	10	9		13,8065
25A658P5	MAD 145135/1	145	135	6,5	6		10,9806
25A661P5	MAD 150125	150	125	20	18,5		29,3896
25A664P5	MAD 150135	150	135	12	11		17,9244



## MAD - UMAD - M (colata)

Codice	Descrizione	Dimensioni				Quantità min.	Prezzo (€ cad.)
		D (mm)	d (mm)	L (mm)	H (mm)		
25A670P5	UMAD 155130	155	130	13	12		26,4828
25A671P5	MAD 155130	155	130	20	18,5		30,2776
25A675P5	MAD 155143	155	143	10	9		14,3718
25A676P5	MAD 157145	157	145	10	9		14,5334
25A677P5	MAD 160130/1	160	130	18	16,5		41,5005
25A678P5	MAD 160130/3	160	130	19	18		41,5005
25A679P5	MAD 160130	160	130	24	22		43,4385
25A680P5	UMAD 160135	160	135	13	12		27,2094
25A682P5	MAD 160135	160	135	20	18,5		31,1658
25A686P5	MAD 160148	160	148	10	9		14,7754
25A687P5	MAD 162150	162	150	10	9		14,8563
25A688P5	UMAD 165140	165	140	13	12		28,0168
25A689P5	MAD 165140	165	140	20	18,5		32,1346
25A691P5	MAD 165153	165	153	10	9		15,0176
25A692P5	MAD 167155	167	155	10	9		15,0985
25A694P5	MAD 170140/1	170	140	19	18		43,1961
25A695P5	MAD 170140	170	140	24	22		43,6805
25A697P5	MAD 170145	170	145	20	18,5		43,6805
25A698P5	UMAD 170150	170	150	11	10		21,7193
25A699P5	MAD 170150/1	170	150	13	12		24,2221
25A703P5	MAD 170158	170	158	10	9		15,2598
25A704P5	MAD 172160	172	160	10	9		15,5022
25A706P5	UMAD 175150	175	150	13	12		29,4702
25A707P5	MAD 175150	175	150	20	18,5		33,9110
25A709P5	MAD 175163	175	163	10	9		15,6636
25A711P5	MAD 180150/1	180	150	20	18,5		47,3945
25A712P5	MAD 180150	180	150	24	22		46,1834
25A713P5	UMAD 180155	180	155	13	12		30,1969
25A714P5	MAD 180155	180	155	20	18,5		34,7991
25A716P5	MAD 180160/1	180	160	19	18		33,2650
25A718P5	MAD 180168	180	168	10	9		15,9059
25A719P5	MAD 182170	182	170	10	9		15,9867
25A720P5	UMAD 185160	185	160	13	12		30,9235
25A721P5	MAD 185160	185	160	20	18,5		35,6873
25A722P5	MAD 185170	185	170	12	11		20,9925
25AA62P5	MAD 185173	185	173	10	9		16,2287
25A723P5	MAD 187175	187	175	10	9		16,3903
25A724P5	MAD 190160	190	160	24	22		48,6863
25A725P5	UMAD 190165	190	165	13	12		31,7309
25A726P5	MAD 190165	190	165	20	18,5		36,6561
25A728P5	MAD 190175	190	175	12	11		21,3961
25A729P5	MAD 190178	190	178	10	9		16,5518
25A730P5	MAD 192180	192	180	10	9		16,6326
25A732P5	UMAD 195170	195	170	13	12		32,4577
25A733P5	MAD 195170	195	170	20	18,5		37,5441
25A735P5	MAD 195183	195	183	10	9		16,7939
25A737P5	UMAD 200160	200	160	22	20		58,1330
25A738P5	MAD 200170/1	200	170	16	15		44,7301
25A740P5	MAD 200170	200	170	24	22		51,1893
25A741P5	UMAD 200175	200	175	13	12		33,1843

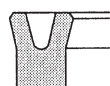

MAD - UMAD - M  
(colata)

Codice	Descrizione	Dimensioni				Quantità min.	Prezzo (€ cad.)
		D (mm)	d (mm)	L (mm)	H (mm)		
25A743P5	MAD 200175	200	175	20	18,5		38,3516
25A745P5	MAD 200180/1	200	180	19	18		36,6561
25A748P5	MAD 202190	202	190	10	9		23,3340
25A749P5	UMAD 205180	205	180	13	12		40,5317
25A750P5	MAD 205180	205	180	20	18,5		45,2145
25A753P5	MAD 207195	207	195	10	9		23,6568
25A754P5	UMAD 210170	210	170	22	20		67,6603
25A755P5	MAD 210180	210	180	24	22		60,0708
25A757P5	UMAD 210185	210	185	13	12		40,6932
25A756P5	MAD 210185	210	185	20	18,5		46,1029
25A759P5	MAD 210195	210	195	12	11		29,4702
25A760P5	MAD 210198	210	198	10	9		23,8990
25A761P5	MAD 212200	212	200	10	9		23,9799
25A762P5	UMAD 215190	215	190	13	12		41,1776
25A763P5	MAD 215190	215	190	20	18,5		46,9908
25A764P5	MAD 215200	215	200	12	11		29,9548
25A765P5	MAD 215203	215	203	10	9		24,1415
25A766P5	MAD 216196/1	216	196	16	15		40,9354
25A767P5	MAD 217205	217	205	10	9		24,3836
25A769P5	UMAD 220180	220	180	22	20		70,6478
25A770P5	MAD 220190	220	190	24	22		62,6545
25A771P5	UMAD 220195	220	195	13	12		41,5813
25A772P5	MAD 220195	220	195	20	18,5		47,9598
25A774P5	MAD 220205	220	205	12	11		30,3584
25A776P5	MAD222210	222	210	10	9		24,6258
25A777P5	UMAD 225200	225	200	13	12		42,0657
25A778P5	MAD 225200	225	200	20	18,5		48,8478
25A779P5	MAD 225210	225	210	12	11		30,8429
25AA67P5	MAD 227215	227	215	10	9		24,8681
25A780P5	UMAD 230190	230	190	22	20		73,7160
25A781P5	MAD 230200/1	230	200	18	17		63,4620
25A782P5	MAD 230200	230	200	24	22		65,1573
25A783P5	UMAD 230205	230	205	13	12		42,5501
25A784P5	MAD 230205	230	205	20	18,5		49,7360
25A786P5	MAD 230215	230	215	12	11		31,3272
25A787P5	MAD 230218	230	218	10	9		25,0295
25A788P5	MAD 232220	232	220	10	9		25,1910
25A789P5	UMAD235210	235	210	13	12		42,9538
25A790P5	MAD 235210	235	210	20	18,5		50,7858
25A791P5	MAD 235220	235	220	12	11		31,7309
25A792P5	MAD 235223	235	223	10	9		25,4332
25A793P5	MAD 237225	237	225	10	9		25,5140
25A794P5	UMAD 240200	240	200	22	20		76,7841
25A795P5	MAD 240210/1	240	210	19	18		68,7101
25A796P5	MAD 240210	240	210	24	22		67,8218
25A797P5	UMAD 240215	240	215	13	12		43,4385
25A798P5	MAD 240215	240	215	20	18,5		51,7545
25A800P5	MAD 240225	240	225	12	11		32,2154
25A801P5	MAD 242230	242	230	10	9		25,8369
25A802P5	UMAD 245220	245	220	13	12		43,8420



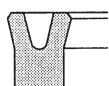

## MAD - UMAD - M (colata)

Codice	Descrizione	Dimensioni				Quantità min.	Prezzo (€ cad.)
		D (mm)	d (mm)	L (mm)	H (mm)		
25A803P5	MAD 245220	245	220	20	18,5	52,6426	
25A804P5	MAD 245230	245	230	12	11	32,6191	
25A806P5	MAD 247235	247	235	10	9	26,1599	
25A807P5	UMAD 250210	250	210	22	20	79,8523	
25A808P5	MAD 250220/1	250	220	19	18	71,2936	
25A809P5	MAD 250220	250	220	24	22	70,3248	
25A810P5	UMAD 250225	250	225	13	12	44,3263	
25A811P5	MAD 250225	250	225	20	18,5	53,6116	
25A813P5	MAD 250235	250	235	12	11	33,1036	
25A814P5	MAD 250238	250	238	10	9	26,3214	
25A815P5	UMAD 255230	255	230	13	12	44,7301	
25A816P5	MAD 255230	255	230	20	18,5	54,4189	
25A817P5	MAD 255240	255	240	12	11	33,5880	
25A818P5	MAD 257245	257	245	10	9	26,8058	
25A819P5	UMAD 260220	260	220	22	20	82,8397	
25A820P5	MAD 260230	260	230	24	22	73,2314	
25A821P5	UMAD 260235	260	235	13	12	45,2145	
25A822P5	MAD 260235	260	235	20	18,5	55,4685	
25A823P5	MAD 260240	260	240	16	15	43,4385	
25A824P5	MAD 260245	260	245	12	11	33,9915	
25A825P5	MAD 260248	260	248	10	9	26,9673	
25A826P5	UMAD 265240	265	240	13	12	45,8604	
25A827P5	MAD 265240	265	240	20	18,5	56,3567	
25A828P5	MAD 265250	265	250	12	11	34,4762	
25A829P5	UMAD 270230	270	230	22	20	85,9077	
25A830P5	MAD 270240	270	240	24	22	75,9767	
25A831P5	UMAD 270245	270	245	13	12	46,5064	
25AA70P5	MAD 270245	270	245	20	18,5	57,2450	
25A832P5	MAD 270250	270	250	16	15	44,3263	
25A833P5	MAD 270255	270	255	12	11	34,8798	
25A834P5	UMAD 275250	275	250	13	12	47,1525	
25A835P5	MAD 275250	275	250	20	18,5	58,1330	
25A836P5	MAD 275260	275	260	12	11	35,3642	
25A837P5	UMAD 280240	280	240	22	20	88,9758	
25A838P5	MAD 280250	280	250	24	22	77,7528	
25A839P5	UMAD 280255	280	255	13	12	47,9598	
25A840P5	MAD 280255	280	255	20	18,5	59,1020	
25A841P5	MAD 280260	280	260	16	15	45,2145	
25A842P5	MAD 280265	280	265	12	11	35,8487	
25A843P5	UMAD 285260	285	260	13	12	48,4442	
25A844P5	MAD 285260	285	260	20	18,5	60,0708	
25A845P5	MAD 285270	285	270	12	11	36,2524	
25A846P5	UMAD 290250	290	250	22	20	92,2054	
25A847P5	MAD 290260	290	260	24	22	80,4981	
25A848P5	UMAD 290265	290	265	13	12	49,0094	
25A849P5	MAD 290265	290	265	20	18,5	60,9589	
25A850P5	MAD 290270	290	270	16	15	46,9908	
25A851P5	MAD 290275	290	275	12	11	36,6561	
25A852P5	UMAD 295270	295	270	13	12	49,6552	
25A853P5	MAD 295270	295	270	20	18,5	61,9278	



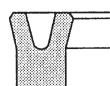

MAD - UMAD - M  
(colata)

Codice	Descrizione	Dimensioni				Quantità min.	Prezzo (€ cad.)
		D (mm)	d (mm)	L (mm)	H (mm)		
25A854P5	MAD 295280	295	280	12	11		38,9169
25A855P5	UMAD 300260	300	260	22	20		94,9506
25A856P5	MAD 300270/1	300	270	16	15		73,5545
25A857P5	MAD 300270	300	270	24	22		83,1624
25A858P5	UMAD 300275	300	275	13	12		50,3011
25AA71P5	MAD 300275	300	275	20	18,5		56,1145
25A859P5	MAD 300280	300	280	16	15		48,8478
25A860P5	MAD 300285	300	285	12	11		41,5813
25A861P5	UMAD 305280	305	280	13	12		50,9471
25A862P5	MAD 305280	305	280	20	18,5		63,7848
25A863P5	MAD 305290	305	290	12	11		42,4695
25A864P5	UMAD 310270	310	270	22	20		98,0995
25A865P5	MAD 310280	310	280	24	22		89,5409
25A866P5	UMAD 310285	310	285	13	12		51,8353
25A867P5	MAD 310290	310	290	16	15		50,6242
25A868P5	MAD 310295	310	295	12	11		43,4385
25A869P5	UMAD 315290	315	290	13	12		53,3693
25A870P5	MAD 315290	315	290	20	18,5		65,5611
25A871P5	MAD 315300	315	300	12	11		44,3263
25A872P5	UMAD 320280	320	280	22	20		101,2484
25A873P5	MAD 320290	320	290	24	22		92,2054
25A874P5	UMAD 320295	320	295	13	12		54,2575
25A875P5	MAD 320295	320	295	20	18,5		66,4494
25A876P5	MAD 320300	320	300	16	15		52,4812
25A877P5	MAD 320305	320	305	12	11		45,2145
25A878P5	UMAD 325300	325	300	13	12		55,1456
25AB08P5	MAD 325300	325	300	20	18,5		67,9835
25A879P5	UMAD 330290	330	290	22	20		103,9935
25A880P5	MAD 330300	330	300	24	22		94,9506
25A881P5	UMAD 330305	330	305	13	12		56,0339
25A882P5	MAD 330310	330	310	16	15		54,2575
25A883P5	MAD 330315	330	315	12	11		46,9908
25A884P5	UMAD335310	335	310	13	12		57,0027
25A885P5	MAD 335310	335	310	20	18,5		69,3560
25A886P5	MAD 335320	335	320	12	11		47,9598
25A887P5	UMAD 340300	340	300	22	20		107,1423
25A888P5	MAD 340310	340	310	24	22		97,6958
25A889P5	UMAD 340315	340	315	13	12		57,8909
25AA54P5	MAD 340315	340	315	20	18,5		70,5670
25A890P5	MAD 340320	340	320	16	15		56,0339
25A891P5	MAD 340325	340	325	12	11		48,8478
25A892P5	UMAD 345320	345	320	13	12		58,7789
25A893P5	MAD 345320	345	320	20	18,5		72,1012
25A894P5	MAD 345330	345	330	12	11		49,7360
25A895P5	UMAD 350310	350	310	22	20		110,2914
25A896P5	MAD 350320	350	320	24	22		100,3602
25A897P5	UMAD 350325	350	325	13	12		59,6672
25A898P5	MAD 350325	350	325	20	18,5		72,5047
25A899P5	MAD 350330	350	330	16	15		57,8909
25A900P5	MAD 350335	350	335	12	11		50,6242

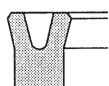

## MAD - UMAD - M (colata)

Codice	Descrizione	Dimensioni				Quantità min.	Prezzo (€ cad.)
		D (mm)	d (mm)	L (mm)	H (mm)		
25A901P5	UMAD 355330	355	330	13	12		60,5553
25A902P5	MAD 355330	355	330	20	18,5		72,9893
25A903P5	MAD 355340	355	340	12	11		52,4812
25A904P5	UMAD 360320	360	320	22	20		113,5209
25AA72P5	MAD 360330	360	330	24	22		103,1054
25A905P5	UMAD 360335	360	335	13	12		61,5241
25A906P5	MAD 360340	360	340	16	15		60,5553
25A907P5	MAD 360345	360	345	12	11		54,2575
25A908P5	UMAD 365340	365	340	13	12		62,4122
25A909P5	MAD 365340	365	340	20	18,5		74,8461
25A910P5	MAD 365350	365	350	12	11		56,0339
25A911P5	UMAD 370330	370	330	22	20		116,6697
25A912P5	MAD 370340	370	340	24	22		105,7698
25A913P5	UMAD 370345	370	345	13	12		63,3004
25A914P5	MAD 370345	370	345	20	18,5		75,9767
25A915P5	MAD 370350	370	350	16	15		63,3004
25A916P5	MAD 370355	370	355	12	11		57,8909
25A917P5	UMAD 375350	375	350	13	12		65,1573
25AA74P5	MAD 375350	375	350	20	18,5		68,0639
25A918P5	MAD 375360	375	360	12	11		59,6672
25A919P5	UMAD 380340	380	340	22	20		119,3341
25A920P5	MAD 380350	380	350	24	22		108,5150
25A921P5	UMAD 380355	380	355	13	12		66,9338
25A922P5	MAD 380360	380	360	16	15		66,0455
25A923P5	MAD 380365	380	365	12	11		61,5241
25A924P5	UMAD 385360	385	360	13	12		68,7101
25A925P5	UMAD 390350	390	350	22	20		122,5637
25A926P5	MAD 390360	390	360	24	22		111,2602
25A927P5	UMAD 390365	390	365	13	12		70,5670
25A928P5	MAD 390365	390	365	20	18,5		79,6099
25A929P5	MAD 390370	390	370	16	15		68,7101
25A930P5	UMAD 395370	395	370	13	12		72,3434
25A931P5	UMAD 400360	400	360	22	20		125,7127
25A932P5	MAD 400370	400	370	24	22		113,9247
25A933P5	UMAD 400375	400	375	13	12		74,1195
25A934P5	MAD 400380	400	380	16	15		71,4552
25A935P5	UMAD 405380	405	380	13	12		75,9767
25A936P5	UMAD 410370	410	370	22	20		141,9414
25A937P5	MAD 410380	410	380	24	22		129,3460
25A938P5	UMAD 410385	410	385	13	12		77,7528
25A939P5	MAD 410385	410	385	20	18,5		94,0624
25A940P5	MAD 410390	410	390	16	15		74,1195
25A941P5	UMAD 415390	415	390	13	12		79,6099
25AA80P5	MAD 415390	415	390	20	18,5		84,7773
25A942P5	UMAD 420380	420	380	22	20		145,5748
25A943P5	UMAD 420395	420	395	13	12		81,3863
25A944P5	MAD 420395	420	395	20	18,5		95,8388
25A945P5	MAD 420400	420	400	16	15		76,8649
25A946P5	UMAD 425400	425	400	13	12		83,1624
25A947P5	MAD 425400	425	400	20	18,5		96,7269

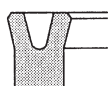

MAD - UMAD - M  
(colata)

Codice	Descrizione	Dimensioni				Quantità min.	Prezzo (€ cad.)
		D (mm)	d (mm)	L (mm)	H (mm)		
25A948P5	UMAD 430390	430	390	22	20		148,3200
25A949P5	MAD 430400	430	400	24	22		135,6436
25A950P5	UMAD 430405	430	405	13	12		85,0196
25A951P5	MAD 430410	430	410	16	15		79,6099
25A952P5	UMAD435410	435	410	13	12		86,7958
25A953P5	UMAD 440400	440	400	22	20		151,9533
25A954P5	MAD 440410	440	410	24	22		138,3889
25A955P5	UMAD 440415	440	415	13	12		88,6530
25A956P5	MAD 440420	440	420	16	15		82,2743
25A957P5	UMAD 445420	445	420	13	12		90,4291
25A958P5	UMAD 450410	450	410	22	20		155,1022
25A959P5	MAD 450420	450	420	24	22		141,0533
25A960P5	UMAD 450425	450	425	13	12		92,2054
25A961P5	MAD 450425	450	425	20	18,5		102,2172
25A962P5	MAD 450430	450	430	16	15		85,9077
25A963P5	UMAD 455430	455	430	13	12		94,0624
25A964P5	MAD 455430	455	430	20	18,5		103,1054
25A965P5	UMAD 460420	460	420	22	20		158,2510
25A966P5	MAD 460430	460	430	24	22		143,7984
25A967P5	UMAD 460435	460	435	13	12		95,8388
25A968P5	MAD 460440	460	440	16	15		89,5409
25A969P5	UMAD 465440	465	440	13	12		97,6958
25A970P5	MAD 465440	465	440	20	18,5		104,9626
25A971P5	UMAD 470430	470	430	22	20		161,8844
25A972P5	MAD 470450	470	450	16	15		93,1744
25A973P5	UMAD 480440	480	440	22	20		164,5489
25A974P5	MAD 480450	480	450	24	22		149,2080
25A975P5	MAD 480460	480	460	16	15		96,7269
25A976P5	UMAD 490450	490	450	22	20		168,1820
25A977P5	MAD 490460	490	460	24	22		152,8414
25A978P5	MAD 490470	490	470	16	15		100,3602
25A979P5	UMAD 500460	500	460	22	20		170,9272
25A980P5	MAD 500470	500	470	24	22		155,5059
25A981P5	MAD 500480	500	480	16	15		103,9935
25A982P5	UMAD 510470	510	470	22	20		181,7465
25A983P5	MAD 510480	510	480	24	22		165,5176
25A984P5	MAD 510490	510	490	16	15		107,6269
25A985P5	UMAD 520480	520	480	22	20		184,4916
25A986P5	MAD 520490	520	490	24	22		168,1820
25A987P5	MAD 520500	520	500	16	15		111,2602
25A988P5	UMAD 530490	530	490	22	20		188,1250
25A989P5	MAD 530500	530	500	24	22		170,9272
25A990P5	MAD 530510	530	510	16	15		114,8128
25A991P5	UMAD 540500	540	500	22	20		191,1931
25AA88P5	MAD 540510	540	510	24	22		173,5916
25A992P5	MAD 540520	540	520	16	15		118,4460
25A993P5	UMAD550510	550	510	22	20		194,4226
25A994P5	MAD 550520	550	520	24	22		176,3369
25A995P5	MAD 550530	550	530	16	15		122,0794
25A996P5	UMAD 560520	560	520	22	20		198,0561

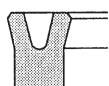

MAD - UMAD - M  
(colata)

Codice	Descrizione	Dimensioni				Quantità min.	Prezzo (€ cad.)
		D (mm)	d (mm)	L (mm)	H (mm)		
25A997P5	MAD 560530	560	530	24	22	179,0821	
25A998P5	MAD 560540	560	540	16	15	126,6009	
25A999P5	UMAD 570530	570	530	22	20	200,7205	
25AA00P5	MAD 570550	570	550	16	15	131,1224	
25AA01P5	UMAD 580540	580	540	22	20	204,3537	
25AA02P5	MAD 580560	580	560	16	15	135,6436	
25AA03P5	UMAD 590550	590	550	22	20	207,0989	
25AA04P5	MAD 590560	590	560	24	22	189,0130	
25AA05P5	MAD 590570	590	570	16	15	140,1651	
25AA06P5	UMAD 600560	600	560	22	20	210,7322	
25AA07P5	MAD 600580	600	580	16	15	144,6866	
25AA08P5	UMAD 610570	610	570	22	20	213,3966	
25AA09P5	MAD 610580	610	580	24	22	186,2678	
25AA10P5	MAD 620590	620	590	24	22	189,0130	
25AA11P5	MAD 620600	620	600	16	15	153,7295	
25AA12P5	MAD 630600	630	600	24	22	191,6774	
25AA13P5	MAD 640610	640	610	24	22	194,4226	
25AA14P5	MAD 660630	660	630	24	22	199,8323	
25AA15P5	MAD 670640	670	640	24	22	202,5774	
25AA16P5	MAD 680650	680	650	24	22	205,2419	
25AA17P5	MAD 700670	700	670	24	22	210,7322	
25AA18P5	MAD 710680	710	680	24	22	213,3966	
25AA19P5	MAD 720690	720	690	24	22	216,1419	
25AA20P5	MAD 730700	730	700	24	22	218,8063	
25AA21P5	MAD 740710	740	710	24	22	221,5514	
25AA22P5	MAD 750720	750	720	24	22	224,2965	

## Guarnizioni di tenuta in poliuretano per movimenti alternativi serie "CSC"

Le guarnizioni a sezione piena della serie CSC sono realizzate in poliuretano 90 Shore A e vengono preferibilmente utilizzate per la tenuta dinamica su steli di cilindri oleodinamici.

Possono essere impiegate per la tenuta dinamica su pistoni, ma solo a singolo effetto.

Grazie alle caratteristiche del materiale e all'elevata durezza, queste guarnizioni garantiscono una notevole resistenza all'abrasione e all'estrusione. La loro struttura robusta ed il buon compression set del materiale, oltre ad assicurare prestazioni elevate ed una lunga durata, favoriscono la tenuta anche a bassissime pressioni.

Il montaggio viene eseguito in cava con spallamento riportato quando il rapporto tra il diametro della sede e la corona "s" è maggiore di 8 su pistone e 12 in cava interna.

Qualora sia necessario utilizzarle per pressioni più elevate le possiamo fornire con durezza 95 Shore A.

### Condizioni di esercizio

Pressione 250 bar  
 Velocità 0,5 m/s  
 Temperatura (P0) -40°C +100°C

### Compounds

Poliuretano 90 Shore A (P0)

### Tolleranze

Le figure sotto riportate indicano rispettivamente le rugosità in  $\mu\text{mRa}$  e le tolleranze dimensionali delle sedi per guarnizioni di tenuta su stelo e pistone.

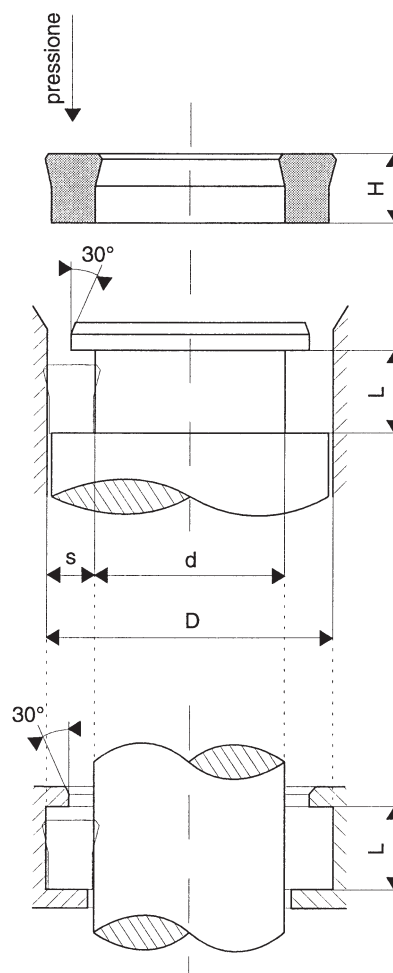
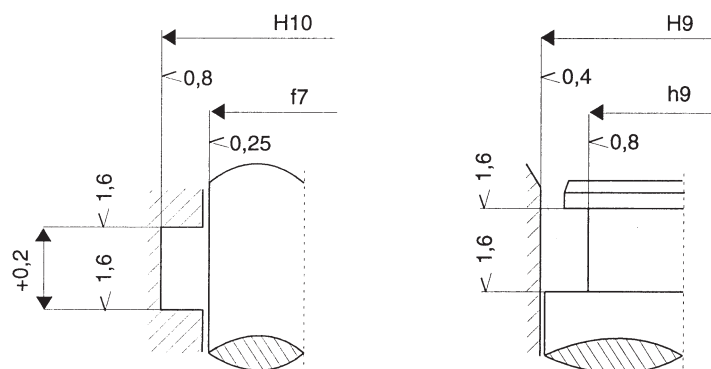

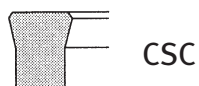

CSC

Codice	Descrizione	Dimensioni				Quantità min.	Prezzo (€ cad.)
		D (mm)	d (mm)	L (mm)	H (mm)		
25B001P0	CSC 72	7	2	4,5	3,7	30	1,0391
25B002P0	CSC 83	8	3	4,5	3,7	30	1,0391
25B003P0	CSC 93	9	3	5	4,5	30	1,0391
25B004P0	CSC 94	9	4	4,5	3,7	30	1,0391
25B005P0	CSC 104	10	4	5	4,5	30	1,0391
25B006P0	CSC 105	10	5	4,5	3,7	30	1,0391
25B007P0	CSC 115	11	5	5	4,5	30	1,0391
25B008P0	CSC 116	11	6	4,5	3,7	30	1,0391
25B009P0	CSC 120/1	12	5	5,5	5	30	1,0391
25B010P0	CSC 126	12	6	5	4,5	30	1,0391
25B011P0	CSC 127	12	7	4,5	3,7	30	1,0391
25B012P0	CSC 127/1	12,7	4,7	7	6,3	30	1,0391
25B013P0	CSC 137	13	7	5	4,5	30	1,0391
25B014P0	CSC 138	13	8	4,5	3,7	30	1,0391
25B015P0	CSC 148	14	8	5	4,5	30	1,0391
25B016P0	CSC 149	14	9	4,5	3,7	30	1,0391
25B017P0	CSC 146/1	14,28	6,35	6,85	6,2	30	1,0391
25B018P0	CSC 158/1	15	8	6,5	6	30	1,1393
25B019P0	CSC 159	15	9	5	4,5	30	1,1393
25B020P0	CSC 1510	15	10	4,5	3,7	30	1,1393
25B021P0	CSC 1610	16	10	5	4,5	30	1,1393
25B022P0	CSC 1611	16	11	4,5	3,7	30	1,1393
25B024P0	CSC 1711	17	11	5	4,5	30	1,1393
25B025P0	CSC 1712	17	12	4,5	3,7	30	1,1393
25B026P0	CSC 188	18	8	8	7,5	30	1,1393
25B027P0	CSC 1810	18	10	6,5	6	30	1,1393
25B028P0	CSC 1812	18	12	5	4,5	30	1,1393
25B029P0	CSC 1813	18	13	4,5	3,7	30	1,1393
25B030P0	CSC 1912/3	19	12	6,3	5,7	30	1,1393
25B031P0	CSC 1912/1	19	12	6,5	6	30	1,1393
25B032P0	CSC 1912/2	19	12	7	6,5	30	1,1393
25B033P0	CSC 1913	19	13	5	4,5	30	1,1393
25B034P0	CSC 1914	19	14	4,5	3,7	30	1,1393
25B035P0	CSC 1912/4	19,05	12,7	5,25	4,7	30	1,1393
25B036P0	CSC 2010	20	10	8	7,5	30	1,2734
25B037P0	CSC 2012	20	12	6,5	6	30	1,2734
25B039P0	CSC 2014	20	14	5	4,5	30	1,2734
25B040P0	CSC 2015	20	15	4,5	3,7	30	1,2734
25B041P0	CSC 2050/1	20,5	13	4,5	4	30	1,2734
25B042P0	CSC 2115	21	15	5	4,5	30	1,2734
25B043P0	CSC 2116	21	16	4,5	3,7	30	1,2734
25B044P0	CSC 2150/1	21,5	17	3,5	3	30	1,2734
25B045P0	CSC 2210	22	10	10	9	30	1,3404
25B046P0	CSC 2212	22	12	8	7,5	30	1,2734
25B047P0	CSC 2214	22	14	7	6	30	1,2734
25B048P0	CSC 2216	22	16	5	4,5	30	1,2734
25B049P0	CSC 2217	22	17	4,5	3,7	30	1,2734
25B050P0	CSC 2220/2	22,22	12,7	7,65	7	30	1,4073
25B051P0	CSC 2220/1	22,22	15,9	5	4,5	30	1,4073
25B052P0	CSC 2312/1	23	12	7,5	7	30	1,4073

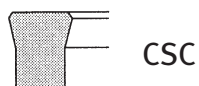

CSC

Codice	Descrizione	Dimensioni				Quantità min.	Prezzo (€ cad.)
		D (mm)	d (mm)	L (mm)	H (mm)		
25B053P0	CSC 2314/1	23	14	6,5	6	30	1,4073
25B054P0	CSC 2315/1	23	15	6,3	5,7	30	1,4073
25B055P0	CSC 2315	23	15	6,5	6	30	1,4073
25B056P0	CSC 2317	23	17	5	4,5	30	1,4073
25B057P0	CSC 2318	23	18	4,5	3,7	30	1,4073
25B059P0	CSC 2412	24	12	10	9	30	1,4073
25B060P0	CSC 2414	24	14	8	7,5	30	1,4073
25B061P0	CSC 2416/1	24	16	6,4	5,7	30	1,4073
25B062P0	CSC 2416	24	16	7	6	30	1,4073
25B063P0	CSC 2418	24	18	5,2	4,5	30	1,4073
25B064P0	CSC 2419	24	19	4,5	4	30	1,4073
25B065P0	CSC 2513	25	13	10	9	30	1,4073
25B066P0	CSC 2515	25	15	8	7,5	30	1,4073
25B067P0	CSC 2517	25	17	6,5	6	30	1,4073
25B068P0	CSC 2518/1	25	18	8	7,5	30	1,4073
25B069P0	CSC 2519	25	19	5	4,5	30	1,4073
25B070P0	CSC 2520	25	20	4,5	3,7	30	1,4073
25B071P0	CSC 2515/1	25,4	15,87	7,65	7	30	1,4073
25B072P0	CSC 2517/1	25,4	17	6,5	6	30	1,4073
25B073P0	CSC 2614	26	14	10	9	30	1,4743
25B074P0	CSC 2616	26	16	8	7,5	30	1,4073
25B075P0	CSC 2618	26	18	7	6	30	1,4073
25B076P0	CSC 2620	26	20	5	4,5	30	1,4073
25B077P0	CSC 2715/1	27	15	7	6	30	1,4743
25B078P0	CSC 2715	27	15	10	9	30	1,4743
25B079P0	CSC 2717	27	17	8	7,5	30	1,4073
25B080P0	CSC 2721	27	21	5	4,5	30	1,4073
25B081P0	CSC 2816/1	28	16	7,5	7	30	1,4743
25B082P0	CSC 2816	28	16	10	9	30	1,4743
25B083P0	CSC 2818/1	28	18	6,3	5,7	30	1,4073
25B084P0	CSC 2818	28	18	8	7,5	30	1,4073
25B085P0	CSC 2820/1	28	20	6,3	5,7	30	1,4073
25B086P0	CSC 2820	28	20	7	6	30	1,4073
25B087P0	CSC 2822	28	22	5	4,5	30	1,4073
25B088P0	CSC 2923	29	23	5	4,5	20	1,4073
25B089P0	CSC 3015/1	30	15	10	9	20	1,6084
25B090P0	CSC 3018/1	30	18	7,5	7	20	1,6084
25B091P0	CSC 3018	30	18	10	9	20	1,6084
25B092P0	CSC 3019/1	30	19,5	7,5	7	20	1,5414
25B093P0	CSC 3020	30	20	8	7,5	20	1,5414
25B095P0	CSC 3022/2	30	22	6,4	5,7	20	1,5414
25B096P0	CSC 3022	30	22	6,5	6	20	1,5414
25B097P0	CSC 3024	30	24	5	4,5	20	1,5414
25B098P0	CSC 3125	31	25	5	4,5	20	1,5414
25B099P0	CSC 3119/1	31,75	19,05	8,5	7,5	20	1,6754
25B100P0	CSC 3218/1	32	18	11,5	10,5	20	1,6084
25B101P0	CSC 3220	32	20	10	9	20	1,6084
25B102P0	CSC 3222	32	22	8	7,5	20	1,5414
25B103P0	CSC 3224	32	24	6,5	6	20	1,5414
25B104P0	CSC 3225/1	32	25,4	4,5	4	20	1,5414



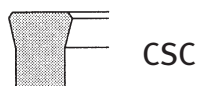

CSC

Codice	Descrizione	Dimensioni				Quantità min.	Prezzo (€ cad.)
		D (mm)	d (mm)	L (mm)	H (mm)		
25B105P0	CSC 3226	32	26	5	4,5	20	1,5414
25B106P0	CSC 3325/2	33	25	6,4	5,7	20	1,5414
25B107P0	CSC 3325	33	25	6,5	6	20	1,5414
25B108P0	CSC 3422/1	34	22	9,5	8,5	20	1,8094
25B109P0	CSC 3424/1	34	24	6,5	6	20	1,8094
25B110P0	CSC 3426	34	26	6,5	6	20	1,8094
25B111P0	CSC 3425/1	34,92	25,4	6,85	6,2	20	1,8094
25B112P0	CSC 3520/1	35	20	10	9	20	1,8765
25B113P0	CSC 3520/2	35	20	11,5	10,5	20	1,8765
25B114P0	CSC 3522/1	35	22	11	10	20	1,8094
25B116P0	CSC 3523	35	23	10	9	20	1,8094
25B117P0	CSC 3525	35	25	8	7,5	20	1,8094
25B118P0	CSC 3525/1	35	25	9	8	20	1,8094
25B119P0	CSC 3527	35	27	6,5	6	20	1,8094
25B120P0	CSC 3624	36	24	10	9	20	1,8094
25B121P0	CSC 3628	36	28	6,5	6	20	1,8094
25B122P0	CSC 3623/1	36,51	23,81	10	9	20	1,8094
25B123P0	CSC 3725	37	25	10	9	20	1,8094
25B124P0	CSC 3730/1	37,5	30	6,5	6	20	1,8094
25B125P0	CSC 3825/1	38	25	10	9	20	2,0105
25B126P0	CSC 3828	38	28	8	7,5	20	1,8765
25B127P0	CSC 3830	38	30	6,5	6	20	1,8765
25B128P0	CSC 3825/2	38,1	25,4	10	9	20	1,9435
25B129P0	CSC 4025/2	40	25	10	9	20	2,0776
25B130P0	CSC 4025/3	40	25	15,5	14,5	20	2,0776
25B131P0	CSC 4026/1	40	26	10	9	20	2,0105
25B132P0	CSC 4028/1	40	28	9,5	8,5	20	2,0105
25B133P0	CSC 4028	40	28	10	9	20	2,0105
25B134P0	CSC 4030/1	40	30	7,5	6,5	20	1,9435
25B135P0	CSC 4030	40	30	8	7,5	20	1,9435
25B136P0	CSC 4032/1	40	32	6	5,5	20	1,9435
25B137P0	CSC 4032	40	32	6,5	6	20	1,9435
25B138P0	CSC 4032/2	40	32	9	8	20	1,9435
25B140P0	CSC 4230	42	30	10	9	20	2,0105
25B141P0	CSC 4232	42	32	8	7,5	20	1,9435
25B142P0	CSC 4232/1	42	32	11	10	20	1,9435
25B144P0	CSC 4335	43	35	6,5	6	20	1,9435
25B145P0	CSC 4336/1	43	36	6,5	6	20	1,9435
25B146P0	CSC 4432	44	32	10	9	20	2,0776
25B147P0	CSC 4434	44	34	8	7,5	20	1,9435
25B148P0	CSC 4436	44	36	6,5	6	20	1,9435
25B149P0	CSC 4440/1	44,4	31,7	8	7,5	20	2,0776
25B150P0	CSC 4530/3	45	30	9	8	20	2,3124
25B151P0	CSC 4530/4	45	30	9,5	8,5	20	2,3124
25B152P0	CSC 4530/2	45	30	10	9	20	2,3124
25B153P0	CSC 4532/1	45	32	10	9	20	2,2116
25B154P0	CSC 4533	45	33	10	9	20	2,2116
25B155P0	CSC 4535	45	35	8	7,5	20	2,1115
25B156P0	CSC 4535/2	45	35	10	9	20	2,1115
25B157P0	CSC 4535/1	45	35	13,5	12,5	20	2,1115



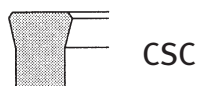

CSC

Codice	Descrizione	Dimensioni				Quantità min.	Prezzo (€ cad.)
		D (mm)	d (mm)	L (mm)	H (mm)		
25B158P0	CSC 4537	45	37	6,5	6	20	2,0776
25B159P0	CSC 4530/1	45,3	33,3	10,5	9,5	20	2,2116
25B160P0	CSC 4636	46	36	8	7,5	20	2,1115
25B161P0	CSC 4735	47	35	10	9	20	2,2116
25B162P0	CSC 4731/1	47,62	31,75	11,6	10,6	20	2,3124
25B163P0	CSC 4836/1	48	36	9,5	8,5	20	2,3794
25B164P0	CSC 4836	48	36	10	9	20	2,3794
25B165P0	CSC 4838	48	38	8	7,5	20	2,2785
25B166P0	CSC 4840	48	40	6,5	6	20	2,1445
25B167P0	CSC 4840/1	48	40	9,5	8,5	20	2,1445
25B168P0	CSC 5030/1	50	30	14,5	13,5	20	2,6806
25B170P0	CSC 5035/1	50	35	10	9	20	2,5466
25B171P0	CSC 5035/2	50	35	11,5	10,5	20	2,5466
25B172P0	CSC 5035	50	35	12	11	20	2,5466
25B173P0	CSC 5038/1	50	38	9,5	8,5	20	2,3794
25B174P0	CSC 5038	50	38	10	9	20	2,3794
25B175P0	CSC 5040/2	50	40	7	6,5	20	2,2785
25B176P0	CSC 5040	50	40	8	7,5	20	2,2785
25B177P0	CSC 5040/3	50	40	10	9	20	2,2785
25B178P0	CSC 5040/1	50	40	11	10	20	2,2785
25B179P0	CSC 5040/4	50	40	13,5	12,5	20	2,2785
25B180P0	CSC 5042	50	42	6,5	6	20	2,1445
25B181P0	CSC 5080/4	50,8	34,92	11,6	10,6	20	2,5466
25B183P0	CSC 5080/2	50,8	38,1	10	9	20	2,3794
25B184P0	CSC 5080/3	50,8	38,1	12,4	11,4	20	2,3794
25B185P0	CSC 5135	51	35	13	12	20	2,4796
25B186P0	CSC 5145/1	51	45	6,5	6	20	2,3794
25B189P0	CSC 5240	52	40	10	9	20	2,3794
25B190P0	CSC 5242	52	42	8	7,5	20	2,2785
25B191P0	CSC 5242/1	52	42	9	8	20	2,2785
25B192P0	CSC 5244	52	44	6,5	6	20	2,0105
25B193P0	CSC 5343/1	53	43	9	8	20	2,4126
25B194P0	CSC 5345	53	45	6,5	6	20	2,3124
25B195P0	CSC 5438	53,97	38,1	12,83	11,8	20	2,7816
25B196P0	CSC 5446/1	54	46	8	7	20	2,3124
25B198P0	CSC 5540/1	55	40	7,5	7	20	2,6806
25B199P0	CSC 5540/2	55	40	11	10	20	2,7816
25B200P0	CSC 5540	55	40	12	11	20	2,7816
25B201P0	CSC 5543	55	43	10	9	20	2,6806
25B202P0	CSC 5545	55	45	8	7,5	20	2,5466
25B203P0	CSC 5545/1	55	45	11	10	20	2,5466
25B204P0	CSC 5547	55	47	6,5	6	20	2,4126
25B205P0	CSC 5640/1	56	40	11	10	20	2,7816
25B206P0	CSC 5640	56	40	13	12	20	2,7816
25B207P0	CSC 5646/1	56	46	8	7,5	20	2,5466
25B208P0	CSC 5648	56	48	6,5	6	20	2,4126
25B209P0	CSC 5745	57	45	10	9	20	2,6806
25B210P0	CSC 5850	58	50	6,5	6	20	2,5466
25B211P0	CSC 5850/1	58	50	12,5	11,5	20	2,5466
25B212P0	CSC 6040/2	60	40	14,5	13,5	20	3,0829

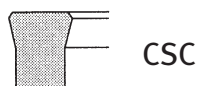

CSC

Codice	Descrizione	Dimensioni				Quantità min.	Prezzo (€ cad.)
		D (mm)	d (mm)	L (mm)	H (mm)		
25B214P0	CSC 6040	60	40	16	15	20	3,0829
25B216P0	CSC 6045/1	60	45	10,5	9,5	20	3,0158
25B217P0	CSC 6045	60	45	12	11	20	3,0158
25B218P0	CSC 6048/1	60	48	7	6,5	20	2,8149
25B219P0	CSC 6048	60	48	10	9	20	2,8149
25B220P0	CSC 6050	60	50	8	7,5	20	2,7478
25B221P0	CSC 6050/1	60	50	10	9	20	2,7478
25B222P0	CSC 6052	60	52	6,5	6	20	2,5466
25B223P0	CSC 6044/1	60,32	44,45	11,6	10,6	20	3,0158
25B224P0	CSC 6050/2	60,35	50,8	11	10	20	2,8149
25B226P0	CSC 6145	61	45	13	12	20	3,0158
25B228P0	CSC 6250/1	62	50	9,5	8,5	20	2,8149
25B229P0	CSC 6250	62	50	10	9	20	2,8149
25B230P0	CSC 6345/1	63	45	11	10	20	3,0829
25B231P0	CSC 6351	63	51	10	9	20	2,8149
25B232P0	CSC 6353	63	53	8	7,5	20	2,7478
25B233P0	CSC 6355	63	55	6,5	6	20	2,5466
25B234P0	CSC 6347/1	63,5	47,62	11,5	10,5	20	3,0829
25B235P0	CSC 6456	64	56	6,5	6	20	2,6476
25B236P0	CSC 6458/1	64	58	6,5	6	20	2,9489
25B238P0	CSC 6545/1	65	45	14,5	13,5	20	3,2506
25B240P0	CSC 6550/2	65	50	11	10	20	3,0829
25B241P0	CSC 6550	65	50	12	11	20	3,0829
25B242P0	CSC 6553	65	53	10	9	20	2,9489
25B243P0	CSC 6555	65	55	8	7,5	20	2,8818
25B244P0	CSC 6555/1	65	55	11	10	20	2,8818
25B245P0	CSC 6557	65	57	6,5	6	20	2,6476
25B246P0	CSC 6550/1	65,5	59	5	4,5	20	2,9489
25B247P0	CSC 6650	66	50	13	12	20	3,9878
25B248P0	CSC 6656	66	56	8	7,5	20	2,8818
25B249P0	CSC 6657/1	66	57	6	5,5	20	2,9489
25B250P0	CSC 6650/1	66,67	50,8	11,5	10,5	20	3,2506
25B252P0	CSC 6755	67	55	10	9	20	3,1500
25B253P0	CSC 6860	68	60	6,5	6	20	2,7816
25B254P0	CSC 6961/1	69	61	8,5	7,5	20	2,9156
25B255P0	CSC 6960/1	69,5	60	7	6,5	20	3,0829
25B256P0	CSC 6957/1	69,85	57,15	10	9	20	3,0829
25B258P0	CSC 7050/1	70	50	14,5	13,5	20	3,3846
25B259P0	CSC 7050	70	50	16	15	20	3,3846
25B260P0	CSC 7054	70	54	13	12	20	3,2839
25B261P0	CSC 7055/1	70	55	10,5	9,5	20	3,2839
25B262P0	CSC 7055	70	55	12	11	20	3,2839
25B263P0	CSC 7058	70	58	10	9	20	3,1500
25B264P0	CSC 7060	70	60	8	7,5	20	3,0158
25B265P0	CSC 7060/1	70	60	13	12	20	3,0158
25B267P0	CSC 7062	70	62	6,5	6	20	3,0158
25B270P0	CSC 7156/1	71	56	10,5	9,5	20	3,2839
25B271P0	CSC 7163	71	63	6,5	6	20	3,0158
25B273P0	CSC 7260	72	60	10	9	20	3,1500
25B275P0	CSC 7363	73	63	8	7,5	20	3,2168

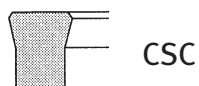

CSC

Codice	Descrizione	Dimensioni				Quantità min.	Prezzo (€ cad.)
		D (mm)	d (mm)	L (mm)	H (mm)		
25B276P0	CSC 7365	73	65	6,5	6	20	3,0829
25B278P0	CSC 7555/1	75	55	13	12	20	3,5519
25B279P0	CSC 7555/2	75	55	14,5	13,5	20	3,5519
25B280P0	CSC 7555	75	55	16	15	20	3,5519
25B282P0	CSC 7560	75	60	12	11	20	3,4517
25B283P0	CSC 7560/1	75	60	13	12	20	3,4517
25B284P0	CSC 7563	75	63	10	9	20	3,2839
25B285P0	CSC 7563/1	75	63	11	10	20	3,2839
25B286P0	CSC 7565	75	65	8	7,5	20	3,2168
25B287P0	CSC 7565/1	75	65	11	10	20	3,2168
25B288P0	CSC 7565/2	75	65	13,5	12,5	20	3,2168
25B289P0	CSC 7567	75	67	6,5	6	20	3,2168
25B290P0	CSC 7656/1	76	56	14,5	13,5	20	3,6860
25B291P0	CSC 7660	76	60	13	12	20	3,6190
25B292P0	CSC 7657/1	76,2	57,15	10	9	20	3,8539
25B293P0	CSC 7663/1	76,2	63,5	8,5	7,5	20	3,4517
25B294P0	CSC 7650/1	76,5	68,5	5	4,5	20	3,4517
25B295P0	CSC 7765	77	65	10	9	20	3,4517
25B296P0	CSC 7862/1	78	62	13	12	20	3,6190
25B297P0	CSC 7863/1	78	63,5	13	12	20	3,6190
25B298P0	CSC 7869/1	78	69	7	6,5	20	3,3509
25B299P0	CSC 7870	78	70	6,5	6	20	3,3509
25B300P0	CSC 7872	78	72	6,5	6	20	3,3509
25B301P0	CSC 8055	80	55	20	18,5	10	4,9932
25B302P0	CSC 8060/1	80	60	13	12	10	3,6860
25B303P0	CSC 8060/2	80	60	14,5	13,5	10	3,6860
25B304P0	CSC 8060	80	60	16	15	10	3,6860
25B306P0	CSC 8065/1	80	65	11,5	10,5	10	3,6190
25B307P0	CSC 8065	80	65	12	11	10	3,6190
25B308P0	CSC 8068	80	68	10	9	10	3,4517
25B309P0	CSC 8070	80	70	8	7,5	10	3,3509
25B310P0	CSC 8070/1	80	70	13	12	10	3,3509
25B311P0	CSC 8072	80	72	6,5	6	10	3,3509
25B314P0	CSC 8270/1	82	70	9,6	8,6	10	3,6528
25B315P0	CSC 8270	82	70	10,5	9,5	10	3,6528
25B316P0	CSC 8220/1	82,2	72,8	7	6,5	10	3,4517
25B317P0	CSC 8263/1	82,55	63,5	14,28	13,3	10	3,8539
25B318P0	CSC 8363/2	83	63	14,5	13,5	10	3,8539
25B319P0	CSC 8375	83	75	6,5	6	10	3,5519
25B320P0	CSC 8470	84	70	12,5	11,5	10	3,7868
25B321P0	CSC 8476	84	76	8,5	7,5	10	3,5519
25B323P0	CSC 8565/1	85	65	13	12	10	3,8539
25B324P0	CSC 8565/2	85	65	14,5	13,5	10	3,8539
25B325P0	CSC 8565	85	65	16	15	10	3,8539
25B327P0	CSC 8570	85	70	12	11	10	3,7868
25B328P0	CSC 8573	85	73	10	9	10	3,6528
25B329P0	CSC 8575	85	75	8	7,5	10	3,5519
25B330P0	CSC 8575/2	85	75	11	10	10	3,5519
25B332P0	CSC 8577	85	77	6,5	6	10	3,5519
25B334P0	CSC 8570/1	85,7	73,3	10,5	9,5	10	3,6528

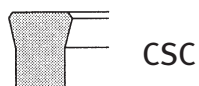

CSC

Codice	Descrizione	Dimensioni				Quantità min.	Prezzo (€ cad.)
		D (mm)	d (mm)	L (mm)	H (mm)		
25B337P0	CSC 8673/1	86	73,3	10,5	9,5	10	3,6528
25B338P0	CSC 8775	87	75	10	9	10	3,8539
25B339P0	CSC 8880	88	80	6,5	6	10	3,7530
25B340P0	CSC 8879/1	88,5	79	7	6,5	10	3,7530
25B341P0	CSC 8873/1	88,9	73,02	12,5	11,5	10	3,8539
25B343P0	CSC 8976/1	89	76,3	7	6,3	10	3,8539
25B345P0	CSC 8975/1	89,5	75	11,5	10,5	10	3,9208
25B347P0	CSC 9070/2	90	70	14,5	13,5	10	4,0212
25B348P0	CSC 9070/1	90	70	13	12	10	4,0212
25B349P0	CSC 9070	90	70	16	15	10	4,0212
25B352P0	CSC 9075/1	90	75	11,5	10,5	10	3,9208
25B353P0	CSC 9075	90	75	12	11	10	3,9208
25B355P0	CSC 9078	90	78	10	9	10	3,8539
25B356P0	CSC 9080/1	90	80	6	5,5	10	3,7530
25B357P0	CSC 9080	90	80	8	7,5	10	3,7530
25B358P0	CSC 9082	90	82	6,5	6	10	3,7530
25B360P0	CSC 9181/1	91	81	8	7,5	10	3,7530
25B361P0	CSC 9276	92	76	13	12	10	4,1551
25B362P0	CSC 9280	92	80	10	9	10	4,0212
25B363P0	CSC 9286/1	92	86	6,5	6	10	3,8871
25B364P0	CSC 9276/1	92,07	76,2	9,53	8,5	10	4,1551
25B366P0	CSC 9385	93	85	6,5	6	10	4,5572
25B370P0	CSC 9575/2	95	75	14,5	13,5	10	4,3229
25B371P0	CSC 9575	95	75	16	15	10	4,3229
25B373P0	CSC 9580	95	80	12	11	10	4,1551
25B375P0	CSC 9583	95	83	10	9	10	4,0212
21B376P0	CSC 9585	95	85	8	7,5	10	3,8871
25B377P0	CSC 9587	95	87	6,5	6	10	3,8871
25B378P0	CSC 9525/1	95,25	76,2	14,8	13,8	10	4,6243
25B381P0	CSC 9680/1	96	80	10,5	9,5	10	4,3899
25B382P0	CSC 9680	96	80	13	12	10	5,4955
25B383P0	CSC 9688/1	96	88	8	7,5	10	4,0880
25B384P0	CSC 9785	97	85	10	9	10	4,2221
25B387P0	CSC 9890	98	90	6,5	6	10	4,0880
25B389P0	C5C 9991/1	99	91	8,5	7,5	10	4,0880
25B392P0	CSC 10080/2	100	80	12	11	10	4,8591
25B393P0	CSC 10080/1	100	80	14	13	10	4,8591
25B394P0	CSC 10080	100	80	16	15	10	4,8591
25B396P0	CSC 10085	100	85	12	11	10	4,3899
25B397P0	CSC 10088	100	88	10	9	10	4,2221
25B398P0	CSC 10090	100	90	8	7,5	10	4,0880
25B399P0	CSC 10090/1	100	90	10,5	9,5	10	4,0880
25B400P0	CSC 10092	100	92	6,5	6	10	4,0880
25B404P0	CSC 10160/2	101,6	82,55	14,8	13,8	10	5,3953
25B407P0	CSC 10290	102	90	10	9	10	4,3899
25B410P0	CSC 10585/1	105	85	14,8	13,8	10	5,2273
25B411P0	CSC 10585	105	85	16	15	10	5,2273
25B413P0	CSC 10590/1	105	90	9,5	8,5	10	4,6913
25B415P0	CSC 10590	105	90	12	11	10	4,6913
25B416P0	CSC 10593	105	93	10	9	10	4,3899

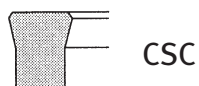

CSC

Codice	Descrizione	Dimensioni				Quantità min.	Prezzo (€ cad.)
		D (mm)	d (mm)	L (mm)	H (mm)		
25B418P0	CSC 10595	105	95	8	7,5	10	4,2221
25B419P0	CSC 10595/1	105	95	11	10	10	4,2221
25B420P0	CSC 10597	105	97	6,5	6	10	4,2221
25B422P0	CSC 10795	107	95	10	9	10	4,7583
25B423P0	CSC 10795/1	107	95	12,5	11,5	10	4,7583
25B425P0	CSC 10750/1	107,5	98	7	6,5	10	4,6243
25B427P0	CSC 108100	108	100	6,5	6	10	4,4232
25B429P0	CSC 11090/2	110	90	12,5	11,5	10	5,5625
25B430P0	CSC 11090/1	110	90	13	12	10	5,5625
25B431P0	CSC 11090	110	90	16	15	10	5,5625
25B433P0	CSC 11095	110	95	12	11	10	4,9932
25B434P0	CSC 11098	110	98	10	9	10	4,7583
25B435P0	CSC 110100	110	100	8	7,5	10	4,6243
25B439P0	CSC 112100	112	100	10	9	10	4,9261
25B440P0	CSC 113100/1	113	100	13,5	12,5	10	5,0933
25B441P0	CSC 113105	113	105	6,5	6	10	4,6243
25B443P0	CSC 11430/3	114,3	95,25	13,5	12,5	10	5,3953
25B449P0	CSC 115100	115	100	12	11	10	5,3953
25B451P0	CSC 115105	115	105	8	7,5	10	4,8253
25B452P0	CSC 115107	115	107	6,5	6	10	4,8253
25B453P0	CSC 115107/1	115	107	8	7,5	10	4,8253
25B454P0	CSC 11595/1	116	95	14,5	13,5	5	5,9984
25B461P0	CSC 118110	118	110	6,5	6	5	4,9932
25B465P0	CSC 120100/2	120	100	12	11	5	6,1656
25B467P0	CSC 120100/3	120	100	14,5	13,5	5	6,1656
25B468P0	CSC 120100	120	100	16	15	5	6,1656
25B469P0	CSC 120105	120	105	12	11	5	5,7635
25B471P0	CSC 120110	120	110	8	7,5	5	5,1943
25B475P0	CSC 122110	122	110	10	9	5	5,3953
25B480P0	CSC 125105/2	125	105	12,5	11,5	5	6,4675
25B483P0	CSC 125105	125	105	16	15	5	6,4675
25B484P0	CSC 125110	125	110	12	11	5	6,0985
25B485P0	CSC 125113	125	113	10	9	5	5,6966
25B486P0	CSC 125115	125	115	8	7,5	5	5,3953
25B487P0	CSC 125117	125	117	6,5	6	5	5,3953
25B489P0	CSC 127115	127	115	10	9	5	5,6966
25B491P0	CSC 128120	128	120	6,5	6	5	5,5963
25B493P0	CSC 130110/2	130	110	12,5	11,5	5	6,7687
25B494P0	CSC 130110/1	130	110	13	12	5	6,7687
25B495P0	CSC 130110	130	110	16	15	5	6,7687
25B496P0	CSC 130115	130	115	12	11	5	6,4006
25B497P0	CSC 130118	130	118	10	9	5	5,8644
25B498P0	CSC 130120	130	120	8	7,5	5	5,5963
25B501P0	CSC 13270/1	132,7	120	10	9	5	5,7635
25B502P0	CSC 133123/1	133	123	8	7,5	5	5,7635
25B503P0	CSC 133125	133	125	6,5	6	5	5,7635
25B504P0	CSC 134126/1	134	126	8	7,5	5	5,7635
25B507P0	CSC 135120	135	120	12	11	5	7,3049
25B509P0	CSC 135125	135	125	8	7,5	5	5,7635
25B511P0	CSC 135127	135	127	6,5	6	5	5,7635

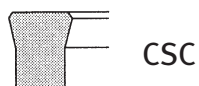

CSC

Codice	Descrizione	Dimensioni				Quantità min.	Prezzo (€ cad.)
		D (mm)	d (mm)	L (mm)	H (mm)		
25B512P0	CSC 137125	137	125	10	9	5	6,5346
25B514P0	CSC 138130	138	130	6,5	6	5	5,9645
25B519P0	CSC 140120/2	140	120	12,5	11,5	5	8,0421
25B520P0	CSC 140120/1	140	120	13	12	5	8,0421
25B521P0	CSC 140120	140	120	16	15	5	8,0421
25B523P0	CSC 140125	140	125	12	11	5	7,1039
25B524P0	CSC 140128	140	128	10	9	5	6,8357
25B525P0	CSC 140130	140	130	8	7,5	5	6,1656
25B526P0	CSC 140132	140	132	6,5	6	5	6,1656
25B532P0	CSC 144134/1	144	134,5	6,5	6	5	6,5346
25B536P0	CSC 145125	145	125	16	15	5	8,3103
25B537P0	CSC 145127/1	145	127	18	17	5	8,4443
25B538P0	CSC 145130	145	130	12	11	5	7,7070
25B539P0	CSC 145130/1	145	130	15	14	5	7,7070
25B544P0	CSC 147135	147	135	10	9	5	7,1039
25B545P0	CSC 147137/1	147	137,5	6,5	6	5	6,5346
25B549P0	CSC 150130	150	130	16	15	5	8,4443
25B550P0	CSC 150135	150	135	12	11	5	7,7070
25B551P0	CSC 150138	150	138	10	9	5	7,3049
25B552P0	CSC 150140	150	140	8	7,5	5	6,9367
25B553P0	CSC 150142	150	142	6,5	6	5	6,9367
25B554P0	CSC 152140	152	140	10	9	5	7,3049
25B560P0	CSC 155140	155	140	12	11	5	8,0421
25B562P0	CSC 155143	155	143	10	9	5	7,7070
25B566P0	CSC 15770/1	157,7	145	10	9	5	8,4443
25B568P0	CSC 158150	158	150	6,5	6	5	7,7070
25B569P0	CSC 159146/1	159	146,3	8	7,5	5	8,0421
25B573P0	CSC 160140/2	160	140	12,5	11,5	5	9,9857
25B574P0	CSC 160140/1	160	140	13	12	5	9,9857
25B575P0	CSC 160140/3	160	140	14,5	13,5	5	9,9857
25B577P0	CSC 160140	160	140	16	15	5	9,9857
25B578P0	CSC 160145	160	145	12	11	5	8,4443
25B580P0	CSC 160150	160	150	8	7,5	5	7,7070
25B582P0	CSC 162150	162	150	10	9	5	8,0458
25B586P0	CSC 165150	165	150	12	11	5	8,4443
25B587P0	CSC 165150/1	165	150	13	15	5	8,4443
25B589P0	CSC 165155	165	155	8	7,5	5	8,0421
25B597P0	CSC 170150/2	170	150	14,5	13,5	5	10,7899
25B598P0	CSC 170150	170	150	16	15	5	10,7899
25B599P0	CSC 170155	170	155	12	11	5	8,8463
25B600P0	CSC 170158	170	158	10	9	5	8,4443
25B601P0	CSC 170160	170	160	8	7,5	5	8,4443
25B608P0	CSC 175160	175	160	12	11	5	9,5835
25B609P0	CSC 175160/1	175	160	16	15	5	9,5835
25B613P0	CSC 17780/1	177,8	165,1	10	9	5	9,2485
25B616P0	CSC 180160/1	180	160	14	13	3	11,5270
25B617P0	CSC 180160	180	160	16	15	3	11,5270
25B619P0	CSC 180165	180	165	12	11	3	10,3877
25B620P0	CSC 180168	180	168	10	9	3	9,9857
25B621P0	CSC 180170	180	170	8	7,5	3	9,5835

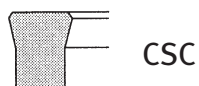

CSC

Codice	Descrizione	Dimensioni				Quantità min.	Prezzo (€ cad.)
		D (mm)	d (mm)	L (mm)	H (mm)		
25B622P0	CSC 182170	182	170	10	9	3	10,3877
25B623P0	CSC 18270/1	182,7	170	10	9	3	10,3877
25B629P0	CSC 185170	185	170	12	11	3	11,9291
25B631P0	CSC 185175	185	175	8	7,5	3	10,3877
25B638P0	CSC 190180	190	180	8	7,5	3	10,7899
25B639P0	CSC 192180	192	180	10	9	3	11,1250
25B641P0	CSC 195180	195	180	12	11	3	11,5270
25B647P0	CSC 197185	197	185	10	9	3	11,5270
25B650P0	CSC 200180/1	200	180	14,5	13,5	3	13,8728
25B651P0	CSC 200180	200	180	16	15	3	15,0119
25B652P0	CSC 200185	200	185	12	11	3	13,0684
25B655P0	CSC 200190	200	190	8	7,5	3	11,5270
25B656P0	CSC 201188/1	201	188,3	7,5	7	3	11,5270
25B661P0	CSC 204191/1	204	191,3	7,5	7	3	12,3312
25B663P0	CSC 205190	205	190	12	11	3	13,8728
25B664P0	CSC 205193	205	193	10	9	3	12,3312
25B666P0	CSC 208196/1	208,7	196	9,5	8,5	3	13,0684
25B671P0	CSC 210190/1	210	190	14,5	13,5	3	15,4141
25B672P0	CSC 210190	210	190	16	15	3	16,0842
25B674P0	CSC 210197/1	210	197,3	7,5	7	3	13,0684
25B676P0	CSC 210200	210	200	8	7,5	3	12,3312
25B677P0	CSC 212200	212	200	10	9	3	13,0684
25B686P0	CSC 220200	220	200	16	15	3	16,9555
25B689P0	CSC 220208	220	208	10	9	3	13,8728
25B690P0	CSC 220210	220	210	8	7,5	3	13,8728
25B696P0	CSC 225210	225	210	12	11	3	15,4141
25B702P0	CSC 230210	230	210	16	15	3	18,4968
25B703P0	CSC 230215	230	215	12	11	3	19,2341
25B707P0	CSC 230220	230	220	8	7,5	3	15,4141
25B720P0	CSC 240220	240	220	16	15	3	20,0384
25B723P0	CSC 240230	240	230	8	7,5	3	16,9555
25B737P0	CSC 250230	250	230	16	15	3	21,5797
25B740P0	CSC 250240	250	240	8	7,5	3	18,4968



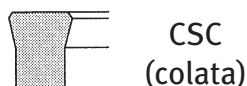

Codice	Descrizione	Dimensioni				Quantità min.	Prezzo (€ cad.)
		D (mm)	d (mm)	L (mm)	H (mm)		
25B391P0	CSC 10075	100	75	20	18,5		20,3465
25B403P0	CSC 10140/1	101,4	95,2	4,5	4		7,4281
25B405P0	CSC 10160/1	101,6	88,9	12	11		12,3532
25B406P0	CSC 10286	102	86	13	12		14,8563
25B408P0	CSC 10395	103	95	6,5	6		8,8814
25B409P0	CSC 10580	105	80	20	18,5		21,2346
25B412P0	CSC 10589	105	89	13	12		15,0985
25B421P0	CSC 10690	106	90	13	12		15,1792
25B424P0	CSC 107101/1	107	101	6,5	6		8,1546
25B426P0	CSC 10890/1	108	90,5	9	8		13,4030
25B428P0	CSC 11085	110	85	20	18,5		22,1228
25B432P0	CSC 11094	110	94	13	12		15,6636
25B436P0	CSC 110102	110	102	6,5	6		9,0430
25B437P0	CSC 11195	111	95	13	12		15,7444
25B438P0	CSC 11296	112	96	13	12		15,8252
25B442P0	CSC 11430/2	114,3	88,9	20	18,5		27,4517
25B444P0	CSC 11430/1	114,3	100	12	11		14,2911
25B445P0	CSC 11590	115	90	20	18,5		23,0918
25B446P0	CSC 11595	115	95	16	15		20,1851
25B447P0	CSC 11599	115	99	13	12		16,0673
25B448P0	CSC 115100/1	115	100	11,5	10,5		14,5334
25B975P0	CSC 115100/2	115	100	13	12		14,7754
25B450P0	CSC 115103	115	103	10	9		12,0305
25B455P0	CSC 116100	116	100	13	12		16,1481
25B456P0	CSC 116107/1	116	107	7	6,5		9,7697
25B457P0	CSC 117100/1	117	100	13	12		16,7939
25B458P0	CSC 117100/2	117	100	14	13		17,5206
25B459P0	CSC 117105	117	105	10	9		12,1110
25B460P0	CSC 11750/1	117,5	108,1	7	6,5		9,7697
25B462P0	CSC 12092/2	120	92	14	13		24,0606
25B463P0	CSC 12092/1	120	92	24	22		34,5571
25B464P0	CSC 12095	120	95	20	18,5		23,9799
25B466P0	CSC 120100/1	120	100	13	12		18,3280
25B470P0	CSC 120108	120	108	10	9		12,2727
25B473P0	CSC 120112	120	112	6,5	6		9,3658
25B474P0	CSC 12060/1	120,6	109,9	10,5	9,5		12,1919
25B476P0	CSC 123115	123	115	6,5	6		9,5273
25B477P0	CSC 123115/1	123	115	8	7,5		9,9311
25B478P0	CSC 123117/1	123	117	6,5	6		8,4777
25B479P0	CSC 125100	125	100	20	18,5		24,8681
25B482P0	CSC 125105/1	125	105	13	12		18,8932
25B488P0	CSC 127112/1	127	112	12	11		15,9059
25B490P0	CSC 128118	128	118	12	11		13,0800
25B499P0	CSC 130122	130	122	6,5	6		9,7697
25B500P0	CSC 132120	132	120	10	9		12,9993
25B505P0	CSC 135110/1	135	110	15,5	14,5		26,5635
25B508P0	CSC 135123	135	123	10	9		13,1606
25B510P0	CSC 135126/1	135	126	7	6,5		10,4963
25B515P0	CSC 13970/1	139,7	114,3	20	18,5		32,9420



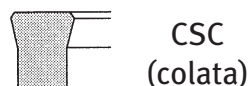

Codice	Descrizione	Dimensioni				Quantità min.	Prezzo (€ cad.)
		D (mm)	d (mm)	L (mm)	H (mm)		
25B516P0	CSC 13970/2	139,7	127	8,5	7,9		12,8378
25B517P0	CSC 140115/1	140	115	16	15		28,0976
25B518P0	CSC 140115	140	115	20	18,5		27,6132
25B527P0	CSC 142130	142	130	10	9		13,6452
25B528P0	CSC 143135	143	135	6,5	6		10,7385
25B529P0	CSC 144127/1	144	127	13	12		19,6199
25B530P0	CSC 144127/2	144	127	14	13		20,5081
25B531P0	CSC 144131/1	144	131	14	13		17,2785
25B533P0	CSC 145120	145	120	20	18,5		28,5014
25B535P0	CSC 145125/1	145	125	14	13		22,3652
25B540P0	CSC 145133	145	133	10	9		13,8065
25B541P0	CSC 145135	145	135	8	7,5		12,1110
25B542P0	CSC 145137	145	137	6,5	6		10,2539
25B543P0	CSC 146120/1	146,05	120,65	20	18,5		34,2340
25B546P0	CSC 148140	148	140	6,5	6		10,3347
25B548P0	CSC 150125	150	125	20	18,5		29,3896
25B556P0	CSC 15240/1	152	139,7	10,5	9,5		14,7754
25B555P0	CSC 152143/1	152	143	6,5	6		10,8194
25B557P0	CSC 153145	153	145	6,5	6		10,4963
25B558P0	CSC 155130/1	155	130	18,8	17,5		34,2340
25B559P0	CSC 155130	155	130	20	18,5		30,2776
25B561P0	CSC 155140/1	155	140	13	12		19,2970
25B563P0	CSC 155145	155	145	8	7,5		12,5956
25B564P0	CSC 155147	155	147	6,5	6		10,5771
25B565P0	CSC 157145	157	145	10	9		14,5334
25B567P0	CSC 158130/1	158	130	24	22		43,4385
25B570P0	CSC 160130/1	160	130	20	18,5		42,3079
25B571P0	CSC 160130	160	130	24	22		41,0161
25B572P0	CSC 160135	160	135	20	18,5		31,1658
25B579P0	CSC 160148	160	148	10	9		14,7754
25B581P0	CSC 160152	160	152	6,5	6		10,7385
25B584P0	CSC 163155	163	155	6,5	6		10,8194
25B585P0	CSC 165140	165	140	20	18,5		32,1346
25B588P0	CSC 165153	165	153	10	9		15,0176
25B590P0	CSC 165157	165	157	6,5	6		10,9806
25B591P0	CSC 167155	167	155	10	9		15,0985
25B592P0	CSC 168160	168	160	6,5	6		11,0614
25B593P0	CSC 170140	170	140	24	22		43,6805
25B594P0	CSC 170144/1	170	144	12	11		27,8554
25B595P0	CSC 170145	170	145	20	18,5		33,0229
25B596P0	CSC 170150/1	170	150	13	12		24,2221
25B602P0	CSC 170162	170	162	6,5	6		11,1421
25B603P0	CSC 171154/1	171	154	13	12		22,4457
25B604P0	CSC 17140/1	171,4	152,4	10	9		20,1044
25B605P0	CSC 172160	172	160	10	9		15,5022
25B606P0	CSC 174145/1	174	145	16	15		38,1094
25B607P0	CSC 175150	175	150	20	18,5		33,9110
25B610P0	CSC 175163	175	163	10	9		15,6636
25B611P0	CSC 175165	175	165	8	7,5		13,5643
25B612P0	CSC 177165	177	165	10	9		15,7444

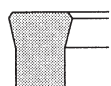

CSC  
(colata)

Codice	Descrizione	Dimensioni				Quantità min.	Prezzo (€ cad.)
		D (mm)	d (mm)	L (mm)	H (mm)		
25B614P0	CSC 180150	180	150	24	22		46,1834
25B615P0	CSC 180155	180	155	20	18,5		34,7991
25B624P0	CSC 183171/1	183	171	8	7,5		14,8563
25B626P0	CSC 18410/1	184,1	152,4	26	24		62,3315
25B627P0	CSC 185160/1	185	160	16	15		36,0908
25B628P0	CSC 185160	185	160	20	18,5		35,6873
25B630P0	CSC 185173	185	173	10	9		16,1481
25B632P0	CSC 187175	187	175	10	9		16,3903
25B633P0	CSC 190160	190	160	24	22		48,6863
25B634P0	CSC 190165	190	165	20	18,5		36,6561
25B635P0	CSC 190170	190	170	16	15		30,7621
25B636P0	CSC 190175	190	175	12	11		21,3961
25B637P0	CSC 190178	190	178	10	9		16,5518
25B640P0	CSC 195170	195	170	20	18,5		37,5441
25B642P0	CSC 195182/1	195	182	7,5	7		15,7444
25B643P0	CSC 195183	195	183	10	9		16,7939
25B644P0	CSC 195185	195	185	8	7,5		14,4526
25B645P0	CSC 196168/1	196	168	23	21		53,4501
25B646P0	CSC 197180/1	197	180	13	12		25,1101
25B648P0	CSC 200170	200	170	24	22		51,1893
25B649P0	CSC 200175	200	175	20	18,5		38,4324
25B654P0	CSC 200188	200	188	10	9		17,6014
25B657P0	CSC 202187/1	202	187	14	13		31,2466
25B659P0	CSC 202190	202	190	10	9		23,3340
25B660P0	CSC 20320/1	203,2	171,4	26	24		76,2994
25B972P0	CSC 205175/1	205	175	20	18,5		67,6603
25B662P0	CSC 205180	205	180	20	18,5		45,2145
25B665P0	CSC 207195	207	195	10	9		23,6568
25B667P0	CSC 209197/1	209	197	8	7,5		22,3652
25B668P0	CSC 210180/1	210	180	21	20		64,6731
25B669P0	CSC 210180	210	180	24	22		60,0708
25B670P0	CSC 210185	210	185	20	18,5		46,1029
25B673P0	CSC 210195	210	195	12	11		29,4702
25B675P0	CSC 210198	210	198	10	9		23,8990
25B678P0	CSC 215190	215	190	20	18,5		46,9908
25B679P0	CSC 215200	215	200	12	11		29,9548
25B680P0	CSC 215203	215	203	10	9		24,1415
25B681P0	CSC 21590/1	215,9	184,1	27,5	25,4		84,3735
25B682P0	CSC 216196/1	216	196	16	15		40,9354
25B683P0	CSC 217205	217	205	10	9		24,2221
25B684P0	CSC 220190	220	190	24	22		62,6545
25B685P0	CSC 220195	220	195	20	18,5		47,9598
25B687P0	CSC 220205	220	205	12	11		30,3584
25B688P0	CSC 220208/1	220	208	7,5	7		22,3652
25B691P0	CSC 222210	222	210	10	9		24,6258
25B694P0	CSC 223210/1	223	210	8	7,5		23,9799
25B695P0	CSC 225200	225	200	20	18,5		48,8478
25B697P0	CSC 225213	225	213	10	9		24,7873
25B698P0	CSC 227215	227	215	10	9		24,8681
25B699P0	CSC 22860/1	228,6	209,5	17	15,9		43,0346

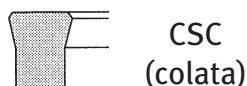

Codice	Descrizione	Dimensioni				Quantità min.	Prezzo (€ cad.)
		D (mm)	d (mm)	L (mm)	H (mm)		
25B700P0	CSC 230200	230	200	24	22		65,1573
25B701P0	CSC 230205	230	205	20	18,5		49,7360
25B704P0	CSC 230217/1	230	217,4	7,5	7		23,8185
25B705P0	CSC 230218/1	230	218	6,7	6,2		21,9615
25B706P0	CSC 230218	230	218	10	9		25,1101
25B708P0	CSC 23170/1	231,7	212,6	15	14		40,3702
25B709P0	CSC 232220	232	220	10	9		25,1910
25B710P0	CSC 234206/1	234	206	24	22		73,3928
25B711P0	CSC 234224/1	234	224	8	7,5		22,4457
25B712P0	CSC 235210	235	210	20	18,5		50,7858
25B713P0	CSC 235220	235	220	12	11		31,7309
25B714P0	CSC 235223/1	235	223	8	7,5		23,6568
25B715P0	CSC 235223	235	223	10	9		25,4332
25B716P0	CSC 237225	237	225	10	9		25,5140
25B717P0	CSC 240210/1	240	210	23,5	21,5		78,3988
25B718P0	CSC 240210	240	210	24	22		67,8218
25B719P0	CSC 240215	240	215	20	18,5		51,7545
25B721P0	CSC 240225	240	225	12	11		32,2154
25B722P0	CSC 240228	240	228	10	9		25,6757
25B724P0	CSC 242230	242	230	10	9		25,8369
25B725P0	CSC 245220	245	220	20	18,5		52,6426
25B726P0	CSC 245220/1	245	220	22	20		65,4805
25B727P0	CSC 245230	245	230	12	11		32,6191
25B728P0	CSC 245233	245	233	10	9		26,0791
25B729P0	CSC 247235	247	235	10	9		26,1599
25B730P0	CSC 24770/1	247,7	215,9	27,5	25,4		95,9195
25B731P0	CSC 248235/1	248	235,3	7,5	7		26,1599
25B732P0	CSC 250220/1	250	220	21	20		75,5729
25B733P0	CSC 250220	250	220	24	22		70,3248
25B734P0	CSC 250225/1	250	225	19,5	18		61,7664
25B736P0	CSC 250225	250	225	20	18,5		53,6116
25B738P0	CSC 250235	250	235	12	11		33,1843
25B739P0	CSC 250238	250	238	10	9		26,3214
25B741P0	CSC 252240	252	240	10	9		26,4020
25B743P0	CSC 255230	255	230	20	18,5		54,4997
25B744P0	CSC 255240	255	240	12	11		33,5880
25B745P0	CSC 255240/1	255	240	13	12		35,1221
25B746P0	CSC 255242/1	255	242,3	7,5	7		26,8865
25B747P0	CSC 255243	255	243	10	9		26,5635
25B748P0	CSC 257245	257	245	10	9		26,8058
25B749P0	CSC 258238/1	258	238	16	15		46,9908
25B750P0	CSC 260230	260	230	24	22		73,2314
25B751P0	CSC 260235	260	235	20	18,5		55,4685
25B752P0	CSC 260240	260	240	16	15		43,4385
25B753P0	CSC 260245	260	245	12	11		33,9915
25B754P0	CSC 260248	260	248	10	9		26,9673
25B755P0	CSC 260250	260	250	8	7,5		23,6568
25B756P0	CSC 26030/1	260,3	228,6	26,5	24,5		97,7765
25B758P0	CSC 265240	265	240	20	18,5		56,3567
25B759P0	CSC 265250	265	250	12	11		34,4762

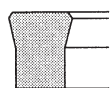

### CSC (colata)

Codice	Descrizione	Dimensioni				Quantità min.	Prezzo (€ cad.)
		D (mm)	d (mm)	L (mm)	H (mm)		
25B760P0	CSC 26670/1	266,7	234,9	27,5	25,4		102,9438
25B761P0	CSC 270240	270	240	24	22		75,9767
25B762P0	CSC 270245	270	245	20	18,5		57,2450
25B763P0	CSC 270250	270	250	16	15		44,3263
25B764P0	CSC 270255	270	255	12	11		34,8798
25B765P0	CSC 270260	270	260	8	7,5		24,1415
25B766P0	CSC 275250	275	250	20	18,5		58,1330
25B767P0	CSC 275260	275	260	12	11		36,2524
25B768P0	CSC 280250	280	250	24	22		77,7528
25B769P0	CSC 280255	280	255	20	18,5		59,1020
25B770P0	CSC 280260	280	260	16	15		45,2145
25B772P0	CSC 280265	280	265	12	11		35,8487
25B774P0	CSC 280270	280	270	8	7,5		24,7066
25B775P0	CSC 282270/1	282	270	7,5	7		25,5948
25B776P0	CSC 285260	285	260	20	18,5		60,0708
25B777P0	CSC 285270	285	270	12	11		36,2524
25B778P0	CSC 290250/1	290	250	24	22		121,2720
25B779P0	CSC 290260	290	260	24	22		80,4981
25B780P0	CSC 290265	290	265	20	18,5		60,9589
25B781P0	CSC 290270	290	270	16	15		46,9908
25B782P0	CSC 290275	290	275	12	11		36,6561
25B783P0	CSC 290280	290	280	8	7,5		29,0665
25B785P0	CSC 29210/2	292,1	272,1	16	15		106,5772
25B786P0	CSC 295270	295	270	20	18,5		61,9278
25B788P0	CSC 295280	295	280	12	11		38,9169
25B789P0	CSC 29840/1	298,4	266,7	26	24		62,8161
25B790P0	CSC 300270	300	270	24	22		83,1624
25B791P0	CSC 300275	300	275	20	18,5		62,8161
25B792P0	CSC 300280	300	280	16	15		48,8478
25B793P0	CSC 300285	300	285	12	11		41,5813
25B794P0	CSC 300290	300	290	8	7,5		25,6757
25B796P0	CSC 305280	305	280	20	18,5		63,7848
25B797P0	CSC 305290	305	290	12	11		42,4695
25B798P0	CSC 310280	310	280	24	22		89,5409
25B799P0	CSC 310285	310	285	20	18,5		64,5922
25B800P0	CSC 310290	310	290	16	15		50,6242
25B801P0	CSC 310295	310	295	12	11		43,4385
25B802P0	CSC 310300	310	300	8	7,5		31,6502
25B804P0	CSC 315290	315	290	20	18,5		65,5611
25B805P0	CSC 315300	315	300	12	11		44,3263
25B807P0	CSC 320290	320	290	24	22		92,2054
25B808P0	CSC 320295	320	295	20	18,5		78,2374
25B809P0	CSC 320300	320	300	16	15		52,4812
25B810P0	CSC 320305	320	305	12	11		47,6367
25B811P0	CSC 320310	320	310	8	7,5		32,5382
25B812P0	CSC 32380/1	323,8	292,1	27,5	25,4		129,1844
25B813P0	CSC 325300	325	300	20	18,5		67,9835
25B814P0	CSC 325310	325	310	12	11		46,1029
25B815P0	CSC 325315	325	315	8	7,5		33,4265
25B816P0	CSC 330300	330	300	24	22		94,9506

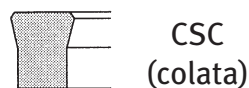

Codice	Descrizione	Dimensioni				Quantità min.	Prezzo (€ cad.)
		D (mm)	d (mm)	L (mm)	H (mm)		
25B817P0	CSC 330305	330	305	20	18,5		68,7101
25B818P0	CSC 330310	330	310	16	15		54,2575
25B819P0	CSC 330315	330	315	12	11		46,9908
25B820P0	CSC 330320	330	320	8	7,5		34,3954
25B821P0	CSC 33020/1	330,2	298,4	27,5	25,4		131,6875
25B822P0	CSC 33020/2	330,2	304,8	27,5	25,4		109,0802
25B823P0	CSC 335310	335	310	20	18,5		69,3560
25B824P0	CSC 335320	335	320	12	11		47,9598
25B825P0	CSC 33650/1	336,5	304,8	27,5	25,4		134,1095
25B826P0	CSC 340310	340	310	24	22		97,6958
25B827P0	CSC 340315	340	315	20	18,5		71,1322
25B828P0	CSC 340320	340	320	16	15		57,2450
25B829P0	CSC 340325	340	325	12	11		48,8478
25B830P0	CSC 340330	340	330	8	7,5		37,0598
25B832P0	CSC 345320	345	320	20	18,5		72,1012
25B833P0	CSC 345330	345	330	12	11		49,7360
25B834P0	CSC 350320	350	320	24	22		100,3602
25B835P0	CSC 350325	350	325	20	18,5		72,5047
25B836P0	CSC 350330	350	330	16	15		57,8909
25B837P0	CSC 350335	350	335	12	11		50,6242
25B838P0	CSC 350340	350	340	8	7,5		38,9169
25B839P0	CSC 355330	355	330	20	18,5		72,9893
25B840P0	CSC 355340	355	340	12	11		52,4812
25B841P0	CSC 355345	355	345	8	7,5		41,1776
25B842P0	CSC 360320/1	360	320	26	24		162,1266
25B843P0	CSC 360330	360	330	24	22		103,1054
25B844P0	CSC 360335	360	335	20	18,5		74,3619
25B845P0	CSC 360340	360	340	16	15		60,5553
25B846P0	CSC 360345	360	345	12	11		54,2575
25B847P0	CSC 360350	360	350	8	7,5		41,5813
25B848P0	CSC 365340	365	340	20	18,5		74,8461
25B849P0	CSC 365350	365	350	12	11		56,0339
25B850P0	CSC 370340	370	340	24	22		105,7698
25B851P0	CSC 370345	370	345	20	18,5		75,9767
25B852P0	CSC 370350	370	350	16	15		63,3004
25B853P0	CSC 370355	370	355	12	11		57,8909
25B854P0	CSC 370360	370	360	8	7,5		42,3887
25B855P0	CSC 375350	375	350	20	18,5		76,2189
25B856P0	CSC 375360	375	360	12	11		59,6672
25B857P0	CSC 380350	380	350	24	22		108,5150
25B858P0	CSC 380555	380	355	20	18,5		76,8649
25B859P0	CSC 380360	380	360	16	15		67,2566
25B860P0	CSC 380365	380	365	12	11		62,3315
25B861P0	CSC 380370	380	370	8	7,5		43,2768
25B862P0	CSC 381354/1	381	354	22	20		107,5460
25B863P0	CSC 38350/1	385	350	25,5	23,5		153,6489
25B864P0	CSC 385360	385	360	20	18,5		78,3988
25B866P0	CSC 390360	390	360	24	22		111,2602
25B867P0	CSC 390365	390	365	20	18,5		79,6099
25B868P0	CSC 390370	390	370	16	15		68,7101

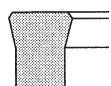

CSC  
(colata)

Codice	Descrizione	Dimensioni				Quantità min.	Prezzo (€ cad.)
		D (mm)	d (mm)	L (mm)	H (mm)		
25B869P0	CSC 390380	390	380	8	7,5		44,2459
25B870P0	CSC 395370	395	370	20	18,5		80,4981
25B871P0	CSC 400370	400	370	24	22		113,9247
25B872P0	CSC 400375	400	375	20	18,5		81,3863
25B873P0	CSC 400380	400	380	16	15		71,4552
25B874P0	CSC 400390	400	390	8	7,5		45,1338
25B875P0	CSC 405380	405	380	20	18,5		90,4291
25B876P0	CSC 410380	410	380	24	22		129,3460
25B877P0	CSC 410385	410	385	20	18,5		94,0624
25B878P0	CSC 410390	410	390	16	15		74,1195
25B879P0	CSC 410400	410	400	8	7,5		56,0339
25B880P0	CSC 415390	415	390	20	18,5		94,9506
25B882P0	CSC 420390	420	390	24	22		132,0105
25B883P0	CSC 420395	420	395	20	18,5		95,8388
25B884P0	CSC 420400	420	400	16	15		76,8649
25B885P0	CSC 420410	420	410	8	7,5		57,0833
25B886P0	CSC 425400	425	400	20	18,5		96,8076
25B888P0	CSC 430400	430	400	24	22		135,6436
25B889P0	CSC 430405	430	405	20	18,5		97,6958
25B890P0	CSC 430410	430	410	16	15		79,6099
25B891P0	CSC 430420	430	420	8	7,5		57,9714
25B893P0	CSC 435410	435	410	20	18,5		99,4720
25B894P0	CSC 440410	440	410	24	22		138,3889
25B895P0	CSC 440415	440	415	20	18,5		100,3602
25B896P0	CSC 440420	440	420	16	15		82,2743
25B897P0	CSC 440430	440	430	8	7,5		58,9404
25B898P0	CSC 445420	445	420	20	18,5		101,2484
25B899P0	CSC 450420	450	420	24	22		141,0533
25B900P0	CSC 450425	450	425	20	18,5		102,2172
25B901P0	CSC 450430	450	430	16	15		85,9077
25B902P0	CSC 450440	450	440	8	7,5		59,8285
25B903P0	CSC 45080/1	450,8	419,1	27,5	25,4		195,2300
25B904P0	CSC 455430	455	430	20	18,5		103,1054
25B905P0	CSC 460430	460	430	24	22		143,7984
25B906P0	CSC 460435	460	435	20	18,5		103,9935
25B907P0	CSC 460440	460	440	16	15		89,5409
25B908P0	CSC 460450	460	450	8	7,5		60,8782
25B909P0	CSC 465440	465	440	20	18,5		104,8817
25B910P0	CSC 470440	470	440	24	22		146,4630
25B911P0	CSC 470450	470	450	16	15		93,1744
25B912P0	CSC 470460	470	460	8	7,5		61,7664
25B913P0	CSC 480450	480	450	24	22		149,2080
25B914P0	CSC 480460	480	460	16	15		96,7269
25B915P0	CSC 480470	480	470	8	7,5		65,0767
25B916P0	CSC 490460	490	460	24	22		152,8414
25B917P0	CSC 490470	490	470	16	15		100,3602
25B918P0	CSC 490480	490	480	8	7,5		67,8218
25B919P0	CSC 500470	500	470	24	22		155,5059
25B920P0	CSC 500480	500	480	16	15		103,9935
25B921P0	CSC 500490	500	490	8	7,5		68,7101



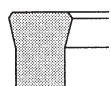

CSC (colata)

Codice	Descrizione	Dimensioni				Quantità min.	Prezzo (€ cad.)
		D (mm)	d (mm)	L (mm)	H (mm)		
25B922P0	CSC 510480	510	480	24	22		165,5176
25B923P0	CSC 510490	510	490	16	15		107,6269
25B925P0	CSC 520490	520	490	24	22		168,1820
25B926P0	CSC 520500	520	500	16	15		111,2602
25B928P0	CSC 530500	530	500	24	22		170,9272
25B930P0	CSC 530510	530	510	16	15		114,8128
25B931P0	CSC 540510	540	510	24	22		173,5916
25B932P0	CSC 540520	540	520	16	15		118,4460
25B933P0	CSC 545535	545	535	8	7,5		88,6530
25B934P0	CSC 550520	550	520	24	22		176,3369
25B935P0	CSC 550530	550	530	16	15		122,0794
25B936P0	CSC 560530	560	530	24	22		179,0821
25B937P0	CSC 560540	560	540	16	15		126,6009
25B938P0	CSC 570540	570	540	24	22		182,6345
25B939P0	CSC 570550	570	550	16	15		131,1224
25B940P0	CSC 580550	580	550	24	22		185,3797
25B941P0	CSC 580560	580	560	16	15		135,6436
25B942P0	CSC 590560	590	560	24	22		189,0130
25B943P0	CSC 590570	590	570	16	15		140,3266
25B945P0	CSC 600570	600	570	24	22		183,6034
25B946P0	CSC 600580	600	580	16	15		144,6866
25B947P0	CSC 610580	610	580	24	22		186,2678
25B948P0	CSC 610590	610	590	16	15		149,2080
25B949P0	CSC 620590	620	590	24	22		189,0130
25B950P0	CSC 620600	620	600	16	15		153,7295
25B951P0	CSC 630600	630	600	24	22		191,6774
25B952P0	CSC 630610	630	610	16	15		158,2510
25B953P0	CSC 630620	630	620	8	7,5		99,4720
25B954P0	CSC 640610	640	610	24	22		194,4226
25B955P0	CSC 650620	650	620	24	22		197,1680
25B956P0	CSC 660630	660	630	24	22		199,8323
25B957P0	CSC 670640	670	640	24	22		202,5774
25B958P0	CSC 680650	680	650	24	22		205,2419
25B959P0	CSC 690660	690	660	24	22		207,9869
25B960P0	CSC 700670	700	670	24	22		210,7322
25B961P0	CSC 710680	710	680	24	22		213,3966
25B962P0	CSC 720690	720	690	24	22		216,1419
25B963P0	CSC 730700	730	700	24	22		218,8063
25B964P0	CSC 740710	740	710	24	22		221,5514
25B965P0	CSC 750720	750	720	24	22		224,2965

GAPI S.p.A.  
Via Molinaretti 2  
24060 Castelli Calepio (Bg) - Italia  
Tel. 030 7438511  
Fax 030 7438550  
E-mail: [sales@gapigroup.com](mailto:sales@gapigroup.com)  
[www.gapigroup.com](http://www.gapigroup.com)

**nacna**<sup>™</sup> products